

MARCH
1937

HOW TO GET TELEVISION

RADIO WORLD

REG. U.S. PAT. OFF.

ANTENNA MYSTERIES EXPLAINED (p.33)

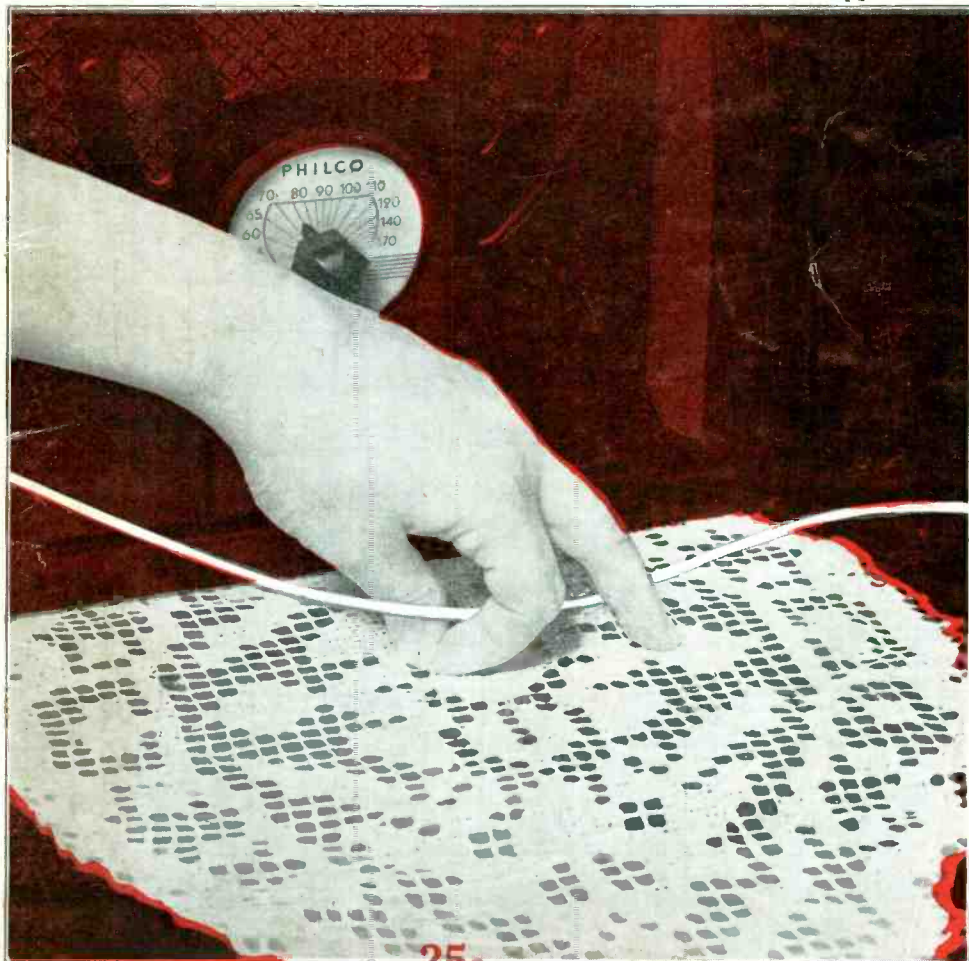

25c

Per Copy

1937



27 YEARS

1910

CORNELL-DUBILIER

CORNELL, DUBILIER CORPORATION SOUTH PLAINFIELD, N. J.

I'LL SEND MY FIRST LESSON FREE



**J. E. Smith, President
National Radio Institute**
The man who has directed the home study training of more men for the Radio Industry than any other man in America.

Here's Proof



**Service
Manager
For Four
Stores**

"I was working in a garage when I enrolled with N. R. I. In a few months I made enough to pay for the course three or four times. I am now Radio service manager for the M. Furniture Co., for their four stores."—JAMES E. RYAN, 1535 Slade St., Fall River, Mass.

**\$10 Week
in
Spare Time**



"My work has consisted of Radio set servicing, with some Public Address Systems work—all in my spare time. My earnings in Radio amount to about \$10 a week."—WILLIAM MEYER, 705 Ridge Road, Hobart, Ind.



**Earnings
Tripled
By N.R.I.
Training**

"I have been doing nicely, thanks to N. R. I. Training. My present earnings are about three times what they were before I took the Course. I consider N. R. I. Training the finest in the world."—BERNARD COSTA, 201 Kent St., Brooklyn, N. Y.

*It Shows How I Train You
at Home in Your Spare Time for a*

GOOD JOB IN RADIO

Clip the coupon and mail it. I will prove to you that I can train you at home in your spare time to be a RADIO EXPERT. I will send you my first lesson FREE. Examine it, read it, see how clear and easy it is to understand—how practical I make learning Radio at home. Then you will know why men without Radio or electrical experience have become Radio Experts and are earning more money than ever as a result of my Training.

**Many Radio Experts Make
\$30, \$50, \$75 a Week**

Radio broadcasting stations employ engineers, operators, station managers and pay up to \$5,000 a year. Spare time Radio set servicing pays as much as \$200 to \$500 a year—full time jobs with Radio jobbers, manufacturers and dealers as much as \$30, \$50, \$75 a week. Many Radio Experts operate their own full time or part time Radio sales and service businesses. Radio manufacturers and jobbers employ testers, inspectors, foremen, engineers, servicemen, paying up to \$6,000 a year. Radio operators on ships get good pay and see the world besides. Automobile, police, aviation, commercial Radio, and loud speaker systems are newer fields offering good opportunities now and for the future. Television promises to open many good jobs soon. Men I have trained are holding good jobs in these branches of Radio. Read their statements. Mail the coupon.

**There's a Real Future in Radio
for Well Trained Men**

Radio already gives jobs to more than 300,000 people. In 1935 over \$500,000,000 worth of sets, tubes and parts were sold—an increase of 20% over 1934! Over 1,100,000 auto Radios were sold in 1935, 25% more than in 1934! 22,000,000 homes are today equipped with Radios, and every year millions of these sets go out of date and are replaced with newer models. Millions more need servicing, new tubes, repairs, etc. Broadcasting stations pay their employees (exclusive of artists) more than \$23,000,000 a year! And Radio is a new industry, still growing fast! A few hundred \$30, \$50, \$75-a-week jobs have grown to many thousands in less than 20 years.

**Many Make \$5, \$10, \$15 a Week Extra
in Spare Time While Learning**

Practically every neighborhood needs a good spare time serviceman. The day you enroll I start sending you Extra Money Job Sheets. They show you how to do Radio repair jobs that you can cash in on quickly. Throughout your training I send you plans that made good spare time money—\$200 to \$500 a year—for hundreds of fellows. My Training is famous as "the Course that pays for itself."

I Give You Practical Experience

My Course is not all book training. I send you special Radio equipment and show you how to conduct experiments and build circuits which illustrate important principles used in modern Radio receivers, broadcast stations and loud speaker



installations. I show you how to build testing apparatus for use in spare time work from this equipment. Read about this 50-50 method of training—how it makes learning at home interesting, quick, fascinating, practical. Mail coupon.

Money Back Agreement Protects You
I am so sure that I can train you successfully that I agree in writing to refund every penny you pay me if you are not satisfied with my Lessons and Instruction Service when you finish. I'll send you a copy of this agreement with my Free Book.

Find Out What Radio Offers You

Mail coupon for sample lesson and 64-page book. Both are free to anyone over 16 years old. My book describes Radio's spare time and full time opportunities and those coming in Television; tells about my training in Radio and Television; shows you actual letters from men I have trained, telling what they are doing and earning. Find out what Radio offers YOU! MAIL THE COUPON in an envelope, or paste it on a penny post card—NOW!

J. E. SMITH, President, Dept. 7CM4
National Radio Institute, Washington, D. C.

**MAIL
COUPON
NOW!**



**GOOD FOR BOTH 64 PAGE BOOK
SAMPLE LESSON FREE**

J. E. SMITH, President, Dept. 7CM4
National Radio Institute, Washington, D. C.

Dear Mr. Smith: Without obligating me, send the sample lesson and your book which tells about the spare time and full time opportunities in Radio and explains your 50-50 method of training men at home in spare time to become Radio Experts. (Please write plainly.)

NAME AGE

ADDRESS

CITY STATE 14x1

**The Tested WAY
to BETTER PAY**



CRYSTAL UNIT

TUNING UNIT

STANDARD "SUPER-PRO" RECEIVER CHASSIS

STANDARD "SUPER-PRO" POWER SUPPLY CHASSIS

The LAST WORD

A SUCCESSFUL radio receiver intended for use over a wide frequency range as well as a wide variety of services must necessarily possess many varied and unusual characteristics. That the new "Super-Pro" completely meets these exacting requisites by means of advanced design and extreme flexibility—rather than by the many compromises resorted to so frequently—is being attested to daily by the many ultra-critical amateurs, engineers, and professional operators now using the new "Super-Pro."

Among the exclusive features in this new 16-tube "Super-Pro" receiver are the special accurately calibrated panel controls: viz., 3 to 16 K.C. continuously variable band-width control; 2500-0-2500 cycle beat oscillator control, and graduated audio and sensitivity controls in addition to a megacycle and kilocycle tuning dial, accurate to within 1/2%, and a 0 to 100 band spread dial. Within the rugged and self-contained tuning unit are a 4-gang tuning condenser, a 12-gang band spread condenser, 20 tuning coils on Isolantite bases, and the remarkably noiseless five-point cam knife-switch which has proven to be absolutely trouble-free!

The fidelity of the new "Super-Pro" is so faithful and the sensitivity so great that it is being used by many news, recording, and broadcast stations for recording and rebroadcast work.

For those who require additional knife-like selectivity for C.W. code, a crystal model is available which when properly adjusted also affords added selectivity for voice and other modulated signals.

Regardless of the complexity of the heavy duty receiving problem you have, the "Super-Pro" will provide the results you want. It is truly "THE LAST WORD"! Send for the new "Super-Pro" bulletin with further details and illustration. Mail the coupon below.

MAIL THIS COUPON !

HAMMARLUND MFG. CO., Inc.,
 424-438 W. 33rd St., New York RW-3

Please send me new "Super-Pro" bulletin.
 Please send me new "37" catalog.

Name

Address

City..... State.....



HAMMARLUND'S 25TH YEAR



**YOU GET A
"BETTER BREAK"
AT W.R.S. Co.**



TRADE in your problems for new 1937 answers—write to our professional problem collectors. They'll help you. Parts list furnished FREE on any circuit described in this magazine. Specify circuit.

LOW COST X-MITTING

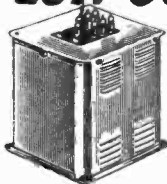

TRANSFORMERS

manufactured by United Transformer Co. ventilated full shields. universal mounting with distinctive silver finish.

Type 20462A—750/1000 volts a.c. ea. side of center tap at 300 ma. T5475.....\$5.70
 Type 20462B—1000/1250/1500 volts a.c. ea. side of center tap at 300 ma. T5476.....\$7.35
 Type 20462C—1500/2000/2500 volts a.c. ea. side of center tap at 300 ma. T5477.....\$11.95

Type 20462D—1000/1250/1500 volts a.c. ea. side of center tap at 500 ma. T5478.....\$11.75
 Type 20462E—575/525 volts a.c. ea. side of center tap at 500 ma. T5479.....\$8.70

Building your own? Buying a new S.W. or all wave receiver? Need a part for a servicing job. Go to **WHOLESALE**. You're bound to get a "BETTER BREAK." With its tremendous purchasing power **WHOLESALE RADIO SERVICE CO.**, offers unbeatable values. Five great branches give you "super swift" service. . . . You get what you want, when you want it!

**NEW FREE
SPRING
CATALOG**

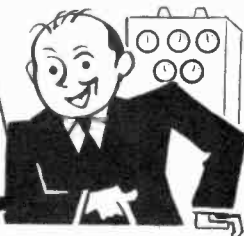

GET THIS 116 PAGE CATALOG

Our new spring catalog will soon be off the press. Your eyes will pop at the thousand and one bargains offered by the world's largest distributor of radio products. Look for the revolutionary **LAFAYETTE** sound systems, the new auto sets . . . the new 1937 **LAFAYETTE** receivers . . . send for your copy at once!

WHOLESALE RADIO SERVICE CO., Inc.
 100 Sixth Avenue, New York, N. Y.

Please rush **FREE** new Spring Catalog No.

68-1107.
 Name
 Address
 City..... State.....

WHOLESALE RADIO SERVICE CO.

NEW YORK, N. Y.
 100 SIXTH AVENUE

CHICAGO, ILL. ATLANTA, GA.
 901 W. JACKSON BLVD. 430 W. PEACHTREE ST., N. W.

ANNOUNCING NEW 1937 THOR ALL-WAVE KITS

THOR'S scientific engineering offers these latest custom-built kits for the experimenter, set builder and amateur. Only the highest quality parts are used in our circuits, developed for the utmost efficiency in all wave reception. All kits come with parts already mounted in scientific alignment and ready to wire.

For the latest and best BUY AT THOR.

MASTERPIECE EIGHT

**3 Band Super.
Automatic Vol.
Control.**

Push-Pull Output.

**6 Watts
Undistorted.**

**Sensitivity
Control.**

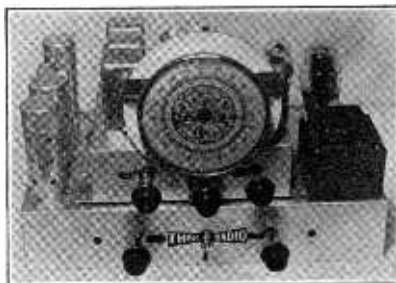

**Pre-selection on
All Bands.**

Full Floating Tuner

**Metal or Glass
Tubes.**

**Full Coverage.
15 to 600 Meters.**

MASTERPIECE 8 is the most modern and powerful receiver Thor has developed. Circuit is full super heterodyne with pre-selection on all bands, a feature designed to give the utmost in sensitivity and selectivity while maintaining a smoothness of operation and absolute one-spot tuning. Complete tuner unit, factory wired and tested is rubber cushion mounted and contained in a separate chassis of its own.

Automatic Volume Control is an integral part of the receiver and its action results in a steady and strong signal over the entire wave band. Push-pull output delivers full 6 watts undistorted. Continuous type tone control. Large 2 ratio vernier aeroplane dial. Chassis 16" long, 10" deep, 11" high. Tube complement 2-6D6, 1-6A7, 1-75, 1-76, 2-42, 1-80 or metal equivalents. Shipping weight 30 lbs. Complete kit of parts, less tubes and speaker

\$21.50

**Tubes and
Speaker
Extra**

**Complete Kit
Ready Mounted on
Floating Chassis**

**Including
Complete tuner unit,
FACTORY WIRED with built-in band switch.**

THORS 2 BAND SUPERHET

A powerful 5-tube superheterodyne covering 2 full bands, 180 to 600 meters on 1 band and 15 to 50 meters on second band. This coverage includes all standard broadcast, all foreign world wide broadcast, 2 amateur bands and 1 police band. Tube complement 1-6A7, 1-6D6, 1-75, 1-43, 1-25Z5. Circuit contains automatic volume control and overload control. All parts including aeroplane dial mounted on chassis 12½" x 8", compact and sensitive designed for either AC-DC operation. Complete parts ready to wire. Speaker and Tubes. \$4.59 extra. Shipping weight, 18 lbs.....

\$10.95

THORS ALL-WAVE CONVERTER

Self-powered unit, easily attached to any broadcast receiver, covers full range 15-600 meters. Built-in band switch, no plug in coils. Connects by 1 wire to aerial. Can be used as remote control unit for regular set as it tunes standard broadcast and acts as pre-selector sharpening tuning and reducing image frequencies. Uses 1-6A7, 1-6D6, 1-25Z5. Illuminated aeroplane dial. Chassis size: 7½" x 10" x 8". Complete parts ready to wire. Shipping weight, 16 lbs.....

\$10.95

Also sold completely wired with tubes....\$14.95

**SEND FOR
FREE
THOR KIT
DIAGRAMS**

**THOR RADIO
65 CORTLANDT STREET
NEW YORK CITY**

**MAIL ORDERS
REQUIRE
20%
DEPOSIT**

MIDWEST..

**FACTORY-TO-YOU
SAVES 50%**

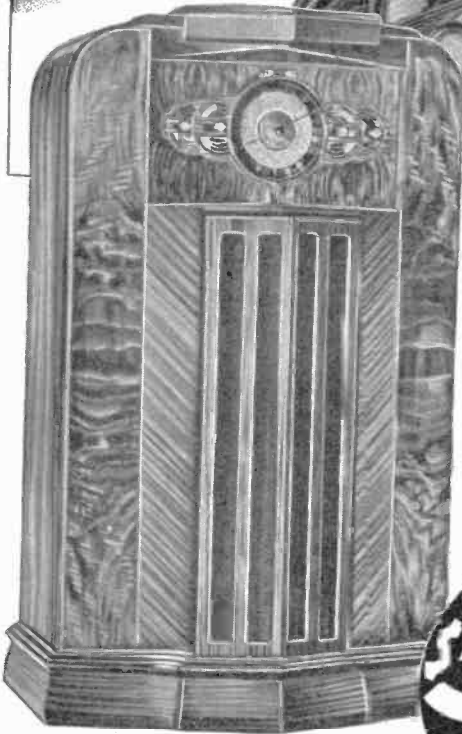

ZIP!
and your
STATION
FLASHES
IN

HALF the Cost... TWICE the Performance

14 TUBES FOR THE PRICE OF 8

This great new Midwest has caught the nation's fancy, because scores of marvelous new features like Dial-A-Matic Tuning*, Elektrik-Saver* (optional*) give magnificent world-wide reception and glorious crystal clear realism. America OK's Midwest radios because they out-perform ordinary sets on a point-for-point comparison. Not a cut-price set, but a more powerful super performing radio in a big, exquisitely designed cabinet

of matched walnut! You are triply protected with Foreign Reception Guarantee . . . One-Year Warranty and Money-Back Guarantee. Now, you can roam the world in a flash . . . switching instantly from American programs to police, amateur, commercial, airplane and ship broadcasts . . . to the most fascinating foreign programs. When you buy the Midwest factory-to-you way, you deal directly with the factory that makes radios — instead of paying extra profits to wholesalers, distributors, retailers, etc.

only
\$39.95
• Buys
A NEW
**1937 WORLD WIDE
MIDWEST**

Send for **FREE**
40-PAGE CATALOG!

Remember! Nothing of value is added to a radio just because it is handled many times. You have a year to pay . . . terms as low as 10c a day . . . you secure the privilege of 30 days FREE trial in your own home.

ZIP! . . . and Your Station Flashes In!

Your radio enjoyment is doubled with Dial-A-Matic Tuning, the amazing new Midwest feature that makes this radio practically tune itself. Zip! . . . Zip! . . . Zip! . . . stations come in instantly, automatically, perfectly . . . as fast as you can push buttons.



Your radio dollar goes twice as far when you buy a MIDWEST!

PASTE COUPON ON 1¢ POSTCARD...OR WRITE TODAY!

MIDWEST RADIO CORPORATION
Dept. K-65 Cincinnati, O.
Send me your new FREE catalog and complete details of your liberal 30-day FREE trial offer.
(Special offer and prices prevail only when dealing direct with factory by mail.)

Name.....
Address.....
Town..... State.....
User-Agents Make Easy Extra Money Check Here for details.

30 DAYS FREE TRIAL!

For seventeen years, Midwest engineers have pioneered many features and advantages which others quickly copied. The new 1937 Midwest is designed years in advance. It has everything! Not just two or three outstanding features, but scores of new developments...many of them exclusive. Send for the FREE 40-page book. See for yourself that Midwest offers today's greatest radio values. See why so many say: "Midwest sets the pace!"



Midwest engineers discussing new chassis

MIDWEST RADIO CORP.

DEPT. K-65 CINCINNATI, OHIO, U.S.A.
Established 1920 Cable Address MIRACD. All Codes

RADIO WORLD

Fifteenth Year

ROLAND BURKE HENNESSY
Editor

H. J. BERNARD
Managing Editor

HERBERT E. HAYDEN
Advertising Manager

Table of Contents for MARCH, 1937

A 6-Tube All-Wave Super..... 9 <i>With Push-Pull Optional</i> By August Klein	The Basic Formulas..... 36 <i>A Valuable Symposium</i> By J. E. Anderson
A Low-Power Transmitter..... 12 <i>Using Spare Parts</i> By M. N. Beitman	Audio Compensation 44 <i>Of Output Circuit</i>
A Universal Probe Lamp..... 14 <i>Neat, Compact Contrivance</i> By Emil Buchwald	Right or Wrong?..... 47 <i>Propositions Test Knowledge</i>
913 Tube Dissected..... 15	A Practical Volume Expander.. 48 <i>Small Outfit for Realism</i> By George V. Du Buc
Television Much Clearer..... 16 <i>Philco Demonstrates 441 Lines</i> By H. J. Bernard	Two New Harmonic Ideas..... 50 <i>Technique's Advance Continues</i> By H. J. Bernard
A Results-Getter's Report..... 19 <i>On His Outstanding Tuner</i> By Charles J. Goss	Questions on Super Pro..... 54 <i>Answered by an Executive</i> By Donald Lewis
How to Get Television..... 22 <i>Methods and Circuits Given</i> By J. E. Anderson	Radio University 57 <i>Technical Queries Answered</i> By RADIO WORLD'S Staff
Mysteries About Aerials..... 33 <i>Neutralization and Wave Traps</i> By Carter English	Tradiograms of the Month..... 58 <i>Parts Shows in Fall</i> <i>Triplett's Anniversary</i> <i>Radio Stores Doomed?</i> <i>Business Flourishes</i>
New Advances in Sound Work.. 34 <i>Hearing Measurements Improved;</i> <i>Pitch and Intensity Compared</i>	Forum 60 <i>Readers' Open Medium of</i> <i>Expression</i>

Vol. XXIX, March, 1937. No. 12. Whole No. 702. RADIO WORLD, published monthly by Hennessy Radio Publications Corporation, 145 West 45th Street, New York, N. Y. Editorial and executive offices, 145 West 45th Street, New York, N. Y. Executives of RADIO WORLD: Roland Burke Hennessy, editor and business manager; H. J. Bernard, managing editor; Herbert E. Hayden, advertising manager. Officers of corporation: Roland Burke Hennessy, president-treasurer; Roland Burke Hennessy, Jr., vice-president; H. J. Bernard, secretary. Entered as second-class matter March, 1922, at the Post Office at New York, N. Y., under Act of March 3rd, 1879.

SUBSCRIPTION RATE

Price 25 cents per copy. Subscription \$2.50 per year (12 issues); \$1.25 per six months (6 issues); postpaid in United States and Possessions; \$3.00 per year, \$1.50 per six months, postpaid in all other countries. Remittance for foreign subscription should be by International money-order (postal or express) or draft against or discountable at New York bank.

RADIO WORLD is distributed by the American News Company and its Branches

Use of a Double Chassis

In a Six- or Eight-Tube Super

By **Aúgust Klein**

Thor Radio Co.

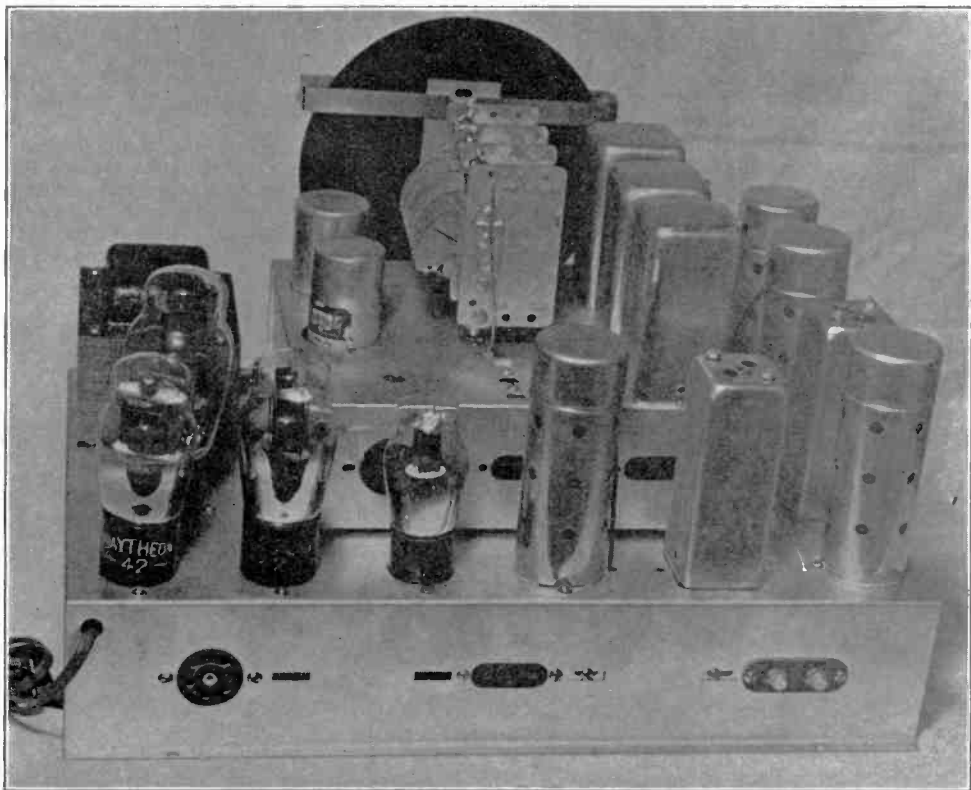

Photographs by Herbert E. Hayden

This photograph of the rear view of the eight-tube super heterodyne, using the push-pull circuit, as explained in the text, instead of the six-tube single-sided circuit, was taken with a polarizing screen in front of the camera lens. The object of the screen, which is adjustable, is to get rid of reflections. This was accomplished as far as desired, as a few reflections on the coil shields and tube shields were purposely allowed, to supply high lights. The photograph was not retouched.

A UNIQUE feature of the construction of this receiver is that it has two chassis, one on top the other. On the smaller chassis are mounted the commercially-made all-wave tuning coils, the main tuning condenser and the dial, together with such small parts as are logically mounted near these parts. This smaller chassis is mounted in the middle of the larger, near its front side. This leaves room on the larger chassis around the two ends and the rear side for the tubes, the i-f transformers, and the power transformer. There are, of course, two under-the-chassis compartments for mounting the various resistors and condensers.

The picture on this page shows the arrange-

ment of the two chassis and the parts on them, whereas that on page 10 shows the underside of the large chassis. It will be observed that the two power supply filter condensers are mounted on the larger chassis but extend up through the smaller.

Another noteworthy feature is the use of a long Bakelite rod for controlling a potentiometer. The purpose of this rod is to permit the mounting of the control on the back side of the larger chassis and thus shortening the leads.

The circuit diagram of the receiver is reproduced on page 11. The circuit is for a single
(Continued on following page)

(Continued from preceding page)
output tube. Provision is made, however, for changing to resistance-coupled push-pull. The output circuit needed if push-pull is to be used is given at the bottom of page 11. The break in the circuit is indicated by a star, both on the push-pull stage and on the original circuit. The method employed for dividing the audio signal into two equal but phase-opposed voltages is that of lifting a heater type tube so that the cathode can be connected to the grid of the second tube of the push-pull amplifier.

8 TUBES FOR PUSH-PULL

When the change is made to push-pull, the grid leak in the input of the power tube is retained, but it is not connected to ground. Instead, a .1 mfd. condenser is placed between ground and the low end of the leak. The top end of the leak goes to the grid cap of the added amplifier instead of to the grid of the power tube. The cathode of the added tube lifted above ground by means of two resistors, one of 3,000 ohms next to the cathode and another of .05 megohm next to ground. Between the junction of these two and the low end of the grid leak is a resistor of .4 megohm. This serves as a sort of stopping resistor. The 3,000-ohm resistor provides grid bias and the

.05-megohm resistor serves as part of the plate coupling resistor. The grounded end of this resistor is at the same potential, as far as a.c. is concerned, as the B plus end of the regular coupling resistor, at least if the last condenser in the B supply filter has a large value.

It will be noted that an extra a-f stage is required for push-pull. In this case the tube is either a 6F5 or a 75, depending on whether metal or glass type tubes are used. Thus the push-pull circuit contains eight tubes.

In the antenna circuit, and used on all tuning bands, is a 456 kc filter. This consists of two chokes placed close together without touching. The stray capacity between them and the inductance of the two chokes forms a series tuned circuit which shorts the input at the 456 kc frequency.

As the signal level at the second detector may be so great on strong local stations that the plate currents are almost cut off, as a result of high voltage from the a.v.c., a sensitivity control consisting of a 25,000-ohm rheostat has been put in the cathode lead of the first or r. f. tube.

BUILT BY THOR

The apparatus pictured was built up by Thor Radio, 65 Cortlandt Street, New York City, who merchandise the kit for this receiver.

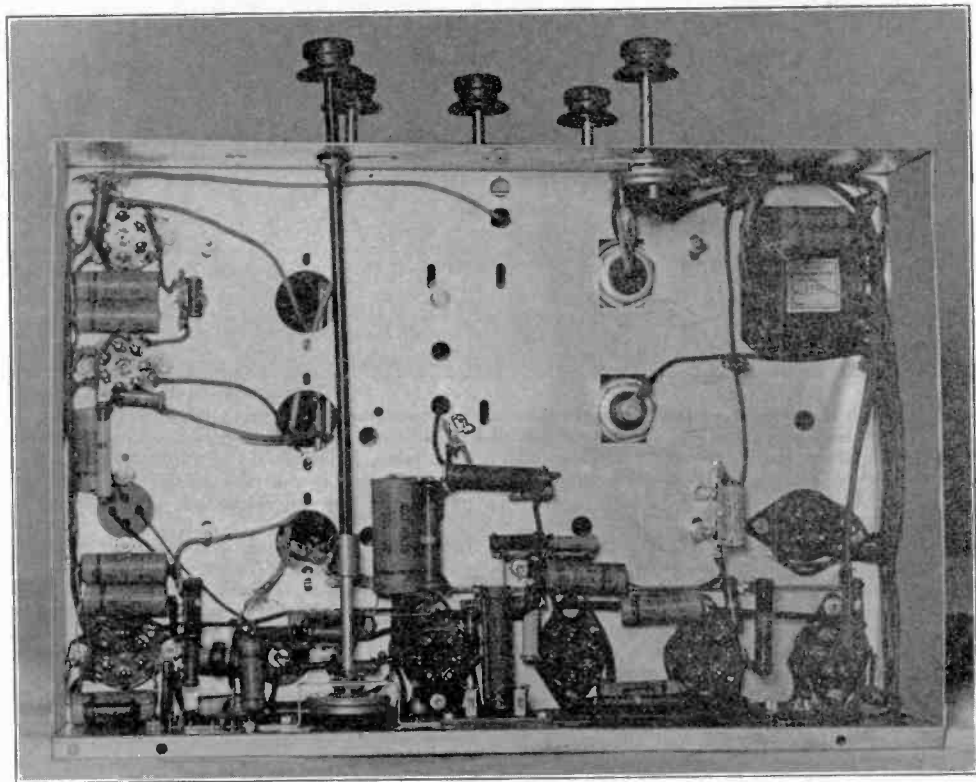

Besides eliminations of reflections, shadows were also sensibly obliterated, by combined use of the polarizing screen and diffused incident light, in taking the unretouched photograph reproduced above, showing the under-view of the chassis.

Low Power Transmitter

With 100% Break-in Facilities

By M. N. Beitman

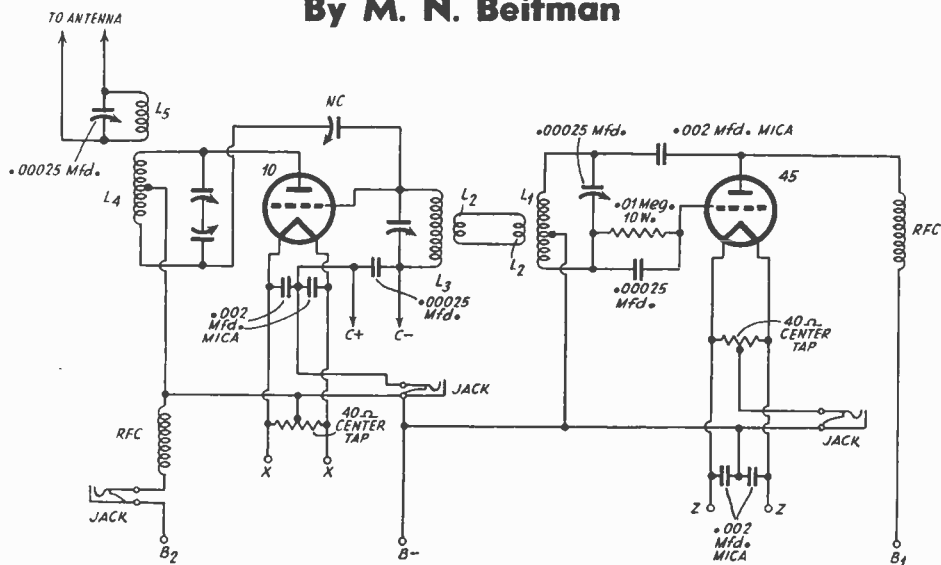

The circuit of a low power transmitter consisting of a master oscillator and a radio power amplifier. An output of 30 watts is possible from the 10 tube. A link coupler is used between the tuned circuits of the oscillator and the input of the power stage.

THE simple two-stage transmitter illustrated can be easily built and adjusted. This transmitter is used by W9NSK for work in the Army Net and produces remarkably clear and powerful signals. An inexpensive receiving type 45-tube is used as a self-excited oscillator. This is link-coupled to a type 10 tube used in the final.

By employing batteries for the C bias, 30-watt input is easy obtainable.

An outstanding feature about this transmitter is the 100% break-in facilities. Note that jacks marked in the schematic as J_x appear in three different places. It is possible, practically without interrupting the operation, to place the key

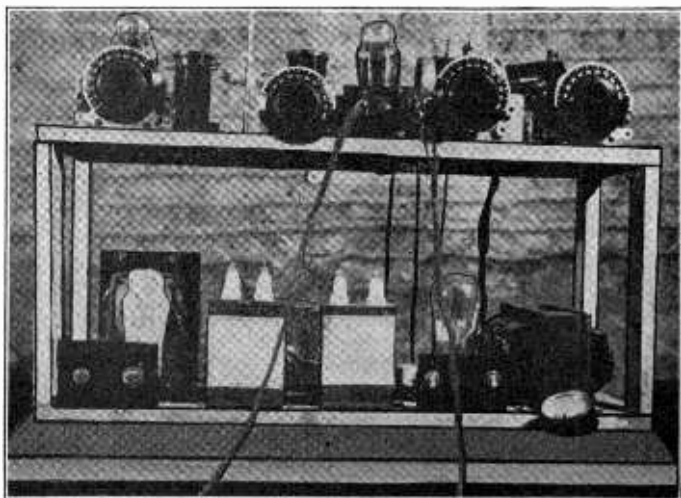

This picture illustrates the method of assembly of the transmitter. On the top shelf are the oscillator and amplifier, with the tuning condensers and coils. Below is the power supply, which is not shown in the diagram. Note that the filter condensers have been designed for very high voltage.

Plan of the assembled transmitter circuit. A metal partition is placed between the self-excited oscillator and the amplifier. The diagram of the power supply circuit is at lower right.

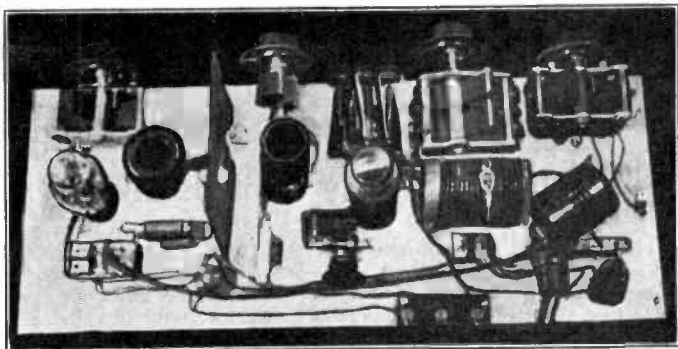

plug into any of these jacks. The keying may therefore be performed in the oscillator, final stage, or on the 110-volt side of the power supply.

A word about the Army Net. This Net consists of regular amateurs somewhat connected with the Army and handling messages for the Army. Certain type of equipment must be used and Army procedure is followed. Z signals are used instead of Q signals. This particular transmitter built for 160-meter operation and the coil data are given for this band.

The power supply, consisting of two distinct

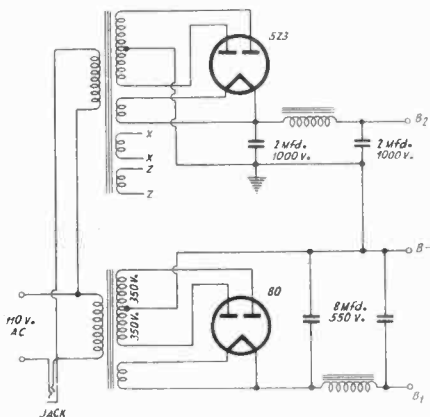

Coil Data for 160-Meter Operation

- $L_1=36$ turns, No. 22 P.E. wire, $1\frac{1}{2}$ " form
- $L_2=2$ -turn link coupling around the coils
- $L_3=40$ turns, No. 14 P.E. wire, $2\frac{1}{4}$ " form
- $L_4=$ Same as L_3
- $L_5=30$ turns, No. 14 P.E. wire, 2" form.

units using 80 and 5Z3 tubes, is housed on the shelf. The transmitter proper is above. A piece of aluminum separates the oscillator from the final stage.

Another transmitter article by M. N. Beitman will be published next month. Here an operator is shown using the transmitter, which has a beam power tube 6L6. The transmitter is natter than the one described this month, as old parts are not used.



A Handy Probing Lamp

Readily Made from 6.3 Volt Pilot

By Emil Buchwald

A LAMP that will not run out of battery power at an inopportune moment is an advantageous device. On the other hand, the wire connecting the lamp to the source of power is a disadvantage, looking at it from a mechanical viewpoint as far as portability is concerned. Between the two, however, the lamp that is prepared to light at any time slightly outweighs the advantage of the battery lamp, since wherever radio service work is performed, power in form of 110 volts a.c. or d.c. is always available and it is merely necessary to make use of it.

The lamp described herein is small and compact, requires no batteries and can be used wherever a power circuit is available as mentioned before. The cost of material is reasonable; all that is necessary is a small piece of brass tubing, a miniature base socket, a line cord resistor such as used on the conventional a.c.-d.c. radios, a 3.2-volt dial lamp and miscellaneous parts usually found about the shop.

RESISTANCE OF LINE CORD

A quick glance at the mathematics of the device will help to clarify matters somewhat. A 3.2 volt dial lamp, such as used radios for dial illumination, draws a current of .35 ampere. Since

$$\text{Resistance} = \frac{\text{Voltage}}{\text{Current}}$$

we find upon computation that the lamp has a resistance of 9.1 ohms. To connect the lamp directly across the 110-volt line will result in disaster and to prevent this a current-limiting resistance must be used.

Using the formula above it will be found that to cause a current of .35 ampere to flow at 110 volts a resistance of 315 ohms is necessary. Subtracting the resistance of the lamp from this

figure results in a value of 305.9 ohms. The nearest value available in line cord resistors is 290 ohms, which is slightly less than the required value, but this is of no great importance as the resistance of the wire increases with heat so that a happy medium will result.

The tubing is merely a four-inch length of brass with an internal diameter of one-half inch. A piece of tin appropriated from an empty tomato can serves as a reflector, which is daubed on the inside with a touch of white paint.

BREAKING IS PREVENTED

Before painting, it would be wise to solder the reflector on the tube first, or discoloration might result. The spring on the end of the tube prevents the wire from breaking at this point. It may be confiscated from a disabled electric iron cord or other fixture cord. Do not run the line cord resistance wire through the metal tube. It becomes uncomfortably warm if you do.

A piece of fixture wire spliced on the line cord resistor, which is run through the tubing, keeps the heat out of the handle. To fasten the miniature socket inside the tube, solder the fixture wire on the socket first and wrap several layers of paper around the socket and part of the wire. Put enough paper on so that the socket fits snugly inside the tube. Remove the ensemble and paint thoroughly with shellac and replace inside the tube to dry.

As an additional precaution, several turns of black thread wrapped around the wire and spring and tied into a knot will help to keep the socket from being pulled down into the tube. All enclosed parts should be well insulated from the tube.

It is advisable not to look into the body cavities with the lamp, as for instance, the examination of teeth or tonsils. A flashlight is recommended for that purpose!

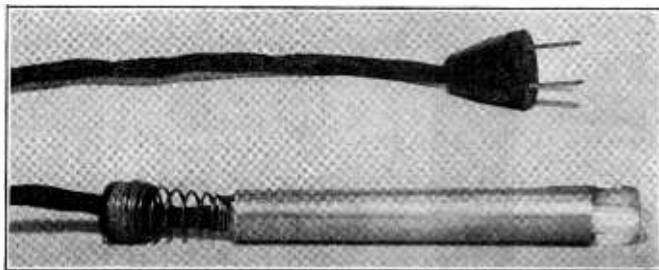

Universal probing lamp as made up by the author. It serves as a continuity tester.

Easy Way for Mounting Meters

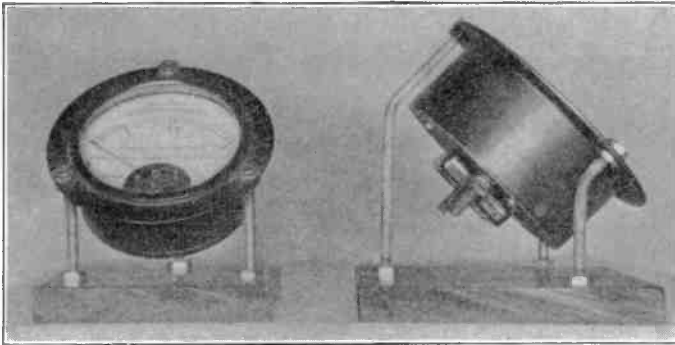

Wooden bases and brass are used in this simple solution of the meter-mounting problem.

Meters may be mounted very easily with the aid of some brass rod and some pieces of wood for bases. A glance at the photograph will clarify the design and construction. As can be seen, the rods support the meter with enough clearance below to take care of connections to the binding posts of the meter. The meters may be mounted as high as possible above the base, merely by increasing the length of the supporting rods.

The rods may be either 5/32 inch in diameter for an 8/32 thread, or 1/8 inch for a 6/32 thread.

It is best to thread three lengths of rod first, then fasten into the flange holes of the meter. The rods are then bent to shape and cut off at the height required. Remove from flange and thread the base ends of the rods. The holes in the base are then marked off and drilled. The underside of the base must be countersunk to take care of the nuts and washers used to fasten the rods to the base. A little varnish on the base completes the job and gives the assembly a better appearance.

—EMIL BUCHWALD

INSIDE STORY OF THE 913 CATHODE - RAY TUBE

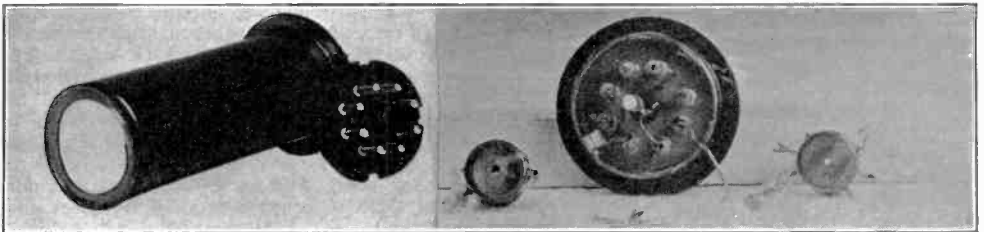

At left is shown a 913 cathode ray tube with the octal base removed. At right is an end-on view of the tube after the base has been removed. The small circles with the central holes are Anodes Nos. 1 and 2.

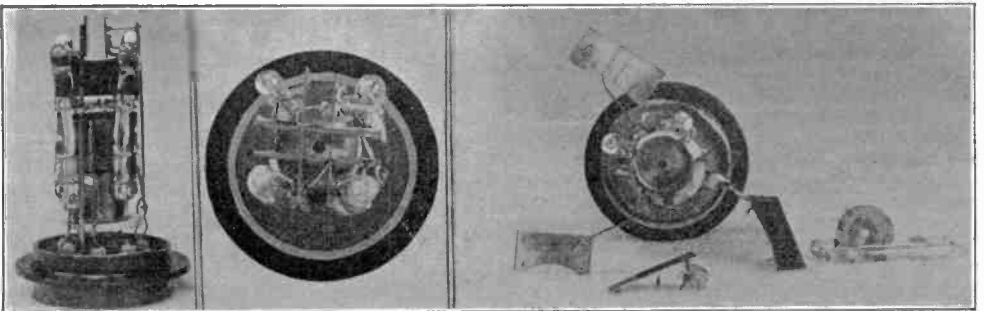

At left is a side view of the internal structure of the 913. In the middle is an end-on view from direction of deflection plates. At right are shown the deflection plates bent away, disclosing Anode No. 1

First Showing of 441 Lines

Philco Black-and-White Television Striking

By H. J. Bernard

CATHODE-RAY television based on 441-line scanning was openly demonstrated recently, for the first time in the United States, by Philco Radio and Television Corporation, in Philadelphia. Six receiver combinations were installed in the auditorium of the Germantown Cricket Club and picked up the short-wave transmissions of television and sound, revealing pictures of occasional brilliance and fine detail, which the increased lineage was intended to accomplish. A still picture, movie film with sound track, and live pickup were demonstrated, of which the live element was by far the best, the still picture good, and the movie reproduction, both as to picture and sound, poor, the sound particularly atrocious.

The demonstration revealed to 150 members of the press another step in the gradual advance in television. The improvement was almost by formula, and was prearranged, since Radio Manufacturers' Association, Inc., had recommended to the Federal Communications Commission increase to 441 lines, and standardization thereon, and the leading television developers in the country are members of the association. It was not assumed to be a revolutionary development, was not announced as such, but was a well-considered stride toward the final goal of pictures that hold high entertaining and educational value.

SIX FEWER TUBES

The advance to 441 lines was from 345 lines, and to achieve it the former transmitter was dismantled and new receivers built, all very costly. The receivers have 26 tubes and 10 controls, reduced from 32 and 14, respectively, in the direction of making relatively inexpensive receivers possible. In England the price of receivers is from \$500 to \$600, with not many sold, while the present Philco receiver probably could be marketed here for \$350, but there is no possibility of it being released this year.

A few months ago the National Broadcasting Company gave a demonstration of the television system developed by the Radio Corporation of America, and since then the NBC equipment has been changed over to 441 lines, and the two methods, Philco and RCA, are running neck and neck at this stage of the television race, with Philco showing what are called black and white pictures, while the RCA demonstration was of pictures in the familiar greenish manner of the service oscilloscopes, but good pictures nevertheless.

There is considerable rivalry between the two groups of television developers, but the common use of the same number of lines removes

one obstacle to television progress, in that a single receiver could react to the emissions of rival stations, whereas formerly a separate receiver for each station would be required. This is a recognition of the necessity of a unified development of television, and concentration on the solution of inherent problems, rather than the wasting of effort on solving problems merely created by stubbornness and hostility. Certain patent exchange agreements also tend toward the elimination of wasted effort.

DIFFERENCE BETWEEN SCANNINGS

Every effort was made at the Philadelphia demonstration to emphasize the difference between the pictures when the scanning was at 441 lines and at 345 lines, a horizontal carrier shift being introduced to render the equivalent of 345-line result, for contrast with the 441-line achievement. There was a noticeable difference, well distributed over the mirror that reflected the one-foot diameter cathode-ray tube's scanning, as to sharpness and contrast of high lights. In some of the pictures, stills and movies, the difference was introduced time and again.

In one particular instance a dollar bill was pasted on a piece of cardboard, with two similar bills, folded in half, one on each side, making a broad letter H, and the trick was to be able to read the serial number of the central bill, the only bill fully exposed. Aside from the fact that picturing of the currency of the United States is mentioned in Federal statutes, the serial number could not be read with certainty, though the observer was only five feet from the screen. When it came to numbers like 1 and 7, with distinguishing characteristics, it would be easy to tell what they are, but to distinguish among 3, 6 and 8 might prove difficult, as it did for these eyes, though aided by glasses. Also, others in attendance could not say that they could read the serial number completely.

This, after all, was a relatively minor point, because the 441 lines did produce an arresting difference when it came to reading type, for instance on part of the front page of "Philco World," where headlines stood out boldly, and black was black in truth. This reproduction was about full size, as the reflecting mirror yields an image $7\frac{1}{2}$ inches high and 10 inches wide.

WHAT CONSOLE LOOKS LIKE

The distance between the Philco factory where the talent did their bits, and the cricket club, is about three miles air line, well within the 10-mile range of the system.

The receiver itself has three chasses: one for television, one for sound and one for deflection. Total power dissipated is 300 watts. Separate sight and sound sets were used, though in the same console, "for flexibility." The console looks much like that of a Philco sound radio set, but has a piano-hinged top, which when lifted reveals the mirror that reflects the images that move on the ray tube's fluorescent surface, composed of zinc sulphide and two other substances.

The still picture, beside the ones of the bills and the house organ, was a head-and-shoulders photograph of Glenda Farrell, the movie actress, and at times it had the crispness of an expert photographer's product. The added clarity provided by the extra lineage made the picture somewhat better, but the difference was not large enough on any tones to be overpowering, rather it showed up most favorably on type. The averaging effect of vision on composite tones defeated the intended markedness, but where the black letters against a white field were demonstrated, and the separation was thus marked, the legibility was of a remarkably high order.

CARTER IN FLESH AND RAY

As many of those present perhaps had never seen any of the persons about to appear before the television camera, an opportunity to compare the reality of the flesh with the reproduction of the ray was afforded when Boake Carter, Philco's news commentator, mingled with the guests at the cricket club, and then sped to the studio, on the top floor of one of the Philco plants, and interviewed Connie Mack, manager and part-owner of the Philadelphia Athletics. It would be insulting to say that Mr. Carter's features were easily identified, as television has passed very far beyond that crude stage. Rather, his features at times appeared on the reflected screen so crisply and realistically than even his twinkling personality came over.

The same would be true of those who had ever seen the others in the flesh, as the writer did in the case of Mr. Mack and of a girl singer, Helen Hughes, who rode in the same coach on the train from New York to Philadelphia with him. She was a pronounced brunette, as if to favor the theory that brunettes make the best subjects for televising, although the color aspects are discounted by Philco engineers as a concession to the shortcomings of some television systems. Therefore the performers did not use makeup, except that girls in a fashion show, and Miss Hughes, resorted to the same makeup, if any, used for a shopping trip. Surely Mr. Mack and Mr. Carter had on no makeup!

NEEDS IMPROVEMENT

Besides the 441 lines, which are not an achievement but rather a sacrifice of time and money in the interest of quality, Philco used its high-fidelity system, passing an extraordinarily wide band of video frequencies.

If the best results that were demonstrated could be continuously attained the pictures could

be regarded as entirely satisfactory for commercial introduction of television at once, provided other obstacles were overcome, such as adequate channel assignments, suitable programs, stations to transmit them, greater service area and moderate price of receivers. However, the excellence was not unmitigated. Sometimes the illumination would disappear almost completely, though not in cyclic periods, and this was not only stated to be a surprise, but was reported as something the Philco engineers had not experienced before, at least not like that. Besides, there was a permanent shortcoming, in the halation at the edges of the picture, as if there was being shown a generally good photograph that, however, had been partly light-struck from the border a bit in, creating the effect of greatest definition at the central portion of the picture. Every effort was made to have the principals in the center, as far as possible, and that may have been no accident. Removal of the halation is most certainly required.

PICTURE LARGE ENOUGH

There was nothing said on Philco's part even to hint that the demonstration approached commercially required quality.

As an example of how good the pictures were when they were at their best, in one instance an announcer standing on the roof of the factory, when direct pickup was being practised, with a very live subject, had to spar for time because a movie film was not quite ready for scanning, and he called attention to the sunlight as it cut across his buttoned overcoat. It so happened that at that very moment one could see the holes in the buttons of the overcoat, and of course the direct sunlight over part of his garment.

The writer had a front-row seat before one of the six receiver combinations, with eye five feet from the mirror. This was about the best position possible, because the picture as scanned comes within the resolving power of the eye at about four feet, hence lines disappear by optical phenomenon, while the limited size of the picture, $7\frac{1}{2} \times 10"$, renders it inadvisable to be at any distance from the mirror much greater than five feet. Nevertheless, the picture is large enough, and television could be in the public's homes to-morrow, if nothing but extra picture size was the deterrent. The size is about as big as it is likely to be for some time to come, because the quantity of obtainable illumination at reasonable cost limits it, projection with present illumination is out of the question, except as a stunt that merely reaffirms the relentless deprivation by the inverse square law of light, and half a dozen or more persons could find full enjoyment, at the present size, if other factors did not interfere.

NO SOUND PROBLEM

The principal objections have been listed, the most important being the unevenness of the illumination from moment to moment, affecting also the definition, as sometimes the picture al-

(Continued on following page)

(Continued from preceding page)

most totally disappears, as it must when the light fails, and secondly, the almost pictureless edges.

As for sound, there is really no problem there, as everything of a vexatious nature is related to the picture. Voice and music, including piano, were excellent on direct pickup, all sound abominable on movie pickup, but that concerned the movie sound track rather than the radio performance. And if the direct pickup of stills and live subjects produced good pictures, and the movies did not, this too must be ascribed to the movies, in the sense that they were not made especially for television, which imposes its own demands. Also, the interrupter in the movie pickup no doubt shut off light that television needed. Large objects in the movies were passable, small objects of dubious identity.

The total image size naturally handicaps the detail of any scenes with small objects, although a small watch's second hand could be read at 441 lines, the scale disappearing at 345 lines.

The movies included a newsreel of the recent flood, with Lowell Thomas as the commentator. His remarkable speaking voice did much to mask the distortion effect, which showed up pointedly later on, when a band of women musicians played, and still later when a woman sang.

Live pickup included the fashion show, revealing good-looking girls in bathing suits, night-gowns and street clothes of the latest styles. The white panties of one of the models showed no contrast against the backdrop of the studio, and in general mild differences in tone were lost to the eye.

The video was modulated on a 49 megacycle carrier, power 4,000 watts, and it was assumed that something caused variation of the effective power output to produce the uneven illumination, as the effect would be the same as that of purposeful modulation by pulses representing black. The sound was sent on 54 megacycles, 250 watts power. The maximum band width of modulation was 4.5 megacycles. The transmitter for both sight and sound was W3XE. Transmitting antennas were 210 feet above the street, for television two dipoles and a reflector, for sound a vertical half-wave antenna. Coaxial transmission lines fed them independently.

TECHNIQUE DESCRIBED

The picture is produced by the following technique: 441 lines; 30 frames, 60 fields (interlaced) per second; 4:3 aspect ratio; transmission polarity negative.

The interlaced scanning is introduced at the transmitter and independently dissected by a reciprocal process in the receiver.

Flicker is conquered. There was none.

Sayre M. Ramsdell, vice-president, opened the session with an informal talk. Larry Gubb, president of the Philadelphia Storage Battery Company, spoke next. James M. Skinner, president of Philco Radio, discussed the channel assignment problem, and Albert F. Murray, Philco engineer in charge of television, explained what scanning is and why not only 441 lines are advisable, but in addition a wide-channel, high-fidelity system.

Features of Demonstration

The outstanding features of the recent Philco television demonstration were:

1. Use of 441 lines in scanning, an increase of 96 lines, to improve the detail.
2. Use of high-fidelity transmission, by passing a much wider band than others consider necessary.
3. Images in black and white, instead of in bluish or greenish hues, using a one-foot diameter tube. Philco's pictures previously were greenish.
4. Extremely short-focus lens used in television camera.
5. Reduction of controls from 14 to 10 and of tubes from 32 to 26.
6. Total power consumption of the three chassis used in the receiver 300 watts.

Improvements deemed requisite are elimination of certain variables that interfere with uniformly constant excellence of pictures, also elimination of border halation, a constant limitation.

The Radio Amateur's Handbook

The new 1937 edition of The Radio Amateur's Handbook, the standard manual of amateur radio communication published by the American Radio Relay League, surpasses any of the previous editions, of which nearly 400,000 copies have been distributed, both in size and quality of practical content. The new edition has a total of 21 chapters with an appendix of miscellaneous practical information, followed by an exceptionally comprehensive topical index which facilitates quick reference.

Many important technical developments during the past year and sweeping changes in operating technique and methods have called for enlargement of the book and rewriting of almost all chapters. Some idea of the extent of the revision may be had from the fact that two hundred new illustrations are included.

Special attention has been given to the new developments in noise silencers for short-wave receivers and to the new technical trends in circuit design. A wealth of new material is added to the wide field of transmitter planning, construction and adjustment. The capabilities of the new tubes are exploited to the full in the radiotelegraph and 'phone transmitter designs presented. Extended space is also given to the ever-important subject of antennas, directional systems and the new ideas in coupling methods being treated in particular detail. The ultra-high frequencies come in for a big share of the space also, new and advanced equipment being detailed to illustrate the latest trends in this rapidly-growing field.

A Results-Getter Reports His Personal Super Meets All Requirements

By Charles J. Goss

There were described last month, in the February issue, the theoretical aspects of this tuner and amplifier. C. J. Goss finally developed the tuner to a state so close to perfection that he got splendid results in selectivity, tone and sensitivity. The circuit as he now uses it was printed last month and is shown again this month for the benefit of those who missed it then. A drawing last month detailed the construction of the variable-coupling i.f. coil. Several photographic views of all the apparatus were printed. This month the author reports practical and constructional experiences.

EDITOR.

THIS article and description of my 13-tube receiver is from the viewpoint of an experimenter and not from that of a technical man.

It is generally accepted that a receiver of more than eight tubes should be left to the engineer but it has always been my belief that with a little patience and a few good tools that most intricate circuits can be copied by any one wishing to apply himself. Even more tubes could be used if some special purposes are to be served.

In this circuit the aim is to build a receiver for the broadcast band with an almost unlimited sensitivity restricted only by the need of quiet operation and not annoying anyone around. It should be able to tune in distant stations with the ease of locals and escape background noise, sideband-cutting, hissing, images, birdies and allied nuisances.

RESULTS COUNT WITH HIM

This receiver is operating within 250 yards of two 120,000-volt high-tension lines and yet at noon on almost any clear day it is able to pull through WOR, Newark, N. J., a distance of about 900 miles, on 710 kc., with the powerful WLW and WGN 10 kc. on each side of WOR and less than 200 miles each from the writer.

Now this was done with the inter-channel noise suppressor in operation. Also at noon this Winter WGY, KOA, WFAA and KDKA were also logged, showing that this receiver has a 1,000-mile range in broad daylight and the whole continental North America in the back yard in the evening and early morning hours. Microvolt sensitivity and all that has its meaning to the radio engineer, for whom I have a high regard, but these things mean more to me.

The coils I first used in the receiver, hooked up for t.r.f., had 127 turns secondary and 22

turns primary wound over secondary, 1" tubing diameter, close winding. This set worked well for a t-r-f circuit. It has selectivity, and tone, was very simple to build and easy on the ears. I let it work through the Summer but then the fading got my goat and of course a super with a.v.c. was the cure for that. So I commenced to add i.f.'s. In doing so I had to eliminate the third r-f tube and substitute an oscillator. I choose a 58 to do the job.

WINDING OSCILLATOR COIL

For the coil I used the same form and wire, only the coil was rewound to make an electron-coupled oscillator with the cathode tap 25 turns from the ground end of the coil. I started with 72 turns and kept cutting off turns till I got down to 68 turns, when the set lined up nicely. The wire size was No. 32 enamel in all instances. For coupling to the detector I used a few turns of insulated wire from the plate of the oscillator tube to the plate lead of the second r-f tube. This did nicely and then later I coupled the plate of the oscillator directly to the suppressor of the first detector and this did much better but still left something to be desired.

More gain was wanted. Another stage of i.f. was the answer and a lot of noise was the result. Looking for a remedy I ran into the interchannel noise suppressor in a tube manual. I spent days doping it out and did much figuring for the voltage divider, with the aid of a good mathematician, and work started on a new second detector. The results were astounding.

Background noise was gone, but by applying enough signal to the 55 I could still go the limit for sensitivity, but with not nearly as much noise as before. All the stations were there, too. On a test it showed 55 stations at noon with the noise suppressor in operation and not all the volume in use.

THE TRIPPING ACTION

Operation of the noise suppressor is controlled by the manual cathode variable resistor, which trips the suppressor as you limit it to a certain amount of signal voltage.

Still going on hunting for more results comparable to those of the best sets, and I consulted some engineers. Most of my trouble at this point was instability of the i.f.'s. Too much bias or cathode voltage had been applied to the r-f amplifiers to get stability. Something around 4.5 volts. A lot of good gain gone up the flue.

(Continued on following page)

(Continued from preceding page)

The engineers said only a nut would try to wind his own r-f and oscillator coils, so they would track, and bad coupling would result. I had no oscilloscope. I only had a good voltmeter and a signal generator. So, they said, change your r-f coils to the high-gain manufactured type and get a manufactured oscillator, also change the first detector to a pentagrid converter. So I placed in my order for the parts and went back to work on the old super. After the manuals were consulted and the desired voltages were found and constants decided on, in went the 2A7 and wow the set was completed. It is now in a cabinet and doing more than nicely.

Now for a little description of the tuner. The diagram is self-explanatory for the parts and tubes. The 45's were selected for output, with two 56's driving them. Of course that will push the 45's until the grids draw current on loud locals but that only wakes up the neighbors. The real results come on weak stations where other sets quit flat.

GOOD ON TONE, TOO

The 45's are good "toners," easy to match and to get parts for (transformers, speakers and information). One thing I did find out about the 45's is that they are excellent for use in dual channel audio amplifiers. One amplifier can be worked with 250 volts on the plates, drawing about 40 to 50 mils for the low notes, and another channel, using a pair of 45's with 350 volts on the plates and biased to about 15 to 20

mils, to give good reproduction on the high notes. With this operation a violin really sounds like a violin, a soprano just as she should and a trumpet just like a trumpet.

In the intermediate stages variable selectivity was wanted, so two of the old r.f., coil cans were soldered together and a variable i.f. manufactured at home. The dowel which the coils were wound around was cut in two and trimmed down to the coils so it could be varied. A high-gain, three-pie-wound coil was used. With this coil ample gain is still to be had when the coils are spaced to the limit and a weak station is coming through.

The transformer is designed around the Hammarlund type, with a bottom movable plate or shelf of Bakelite holding the variable coil. It is moved by a cam made of a piece of thick aluminum screwed to the end of a bookbinder 1/4" shaft, used in offices to hold loose leaf pages together. The bushing through the side of the can was taken from an old variable condenser of an old type battery set. The guides and low-tension springs were made by a gunsmith and also threaded by him. The springs should be very weak so as to make the bottom shelf move up and down easily. The total cost of this transformer is around \$1.20 and a little work.

BOUGHT PARTS FROM ALLIED

The r-f coils cans are 3" diameter, of cadmium plated copper, purchased from Allied Radio in Chicago for 17c each. Two cans are soldered together in each stage. In the tuner using the 2A7 the third can from the front which housed

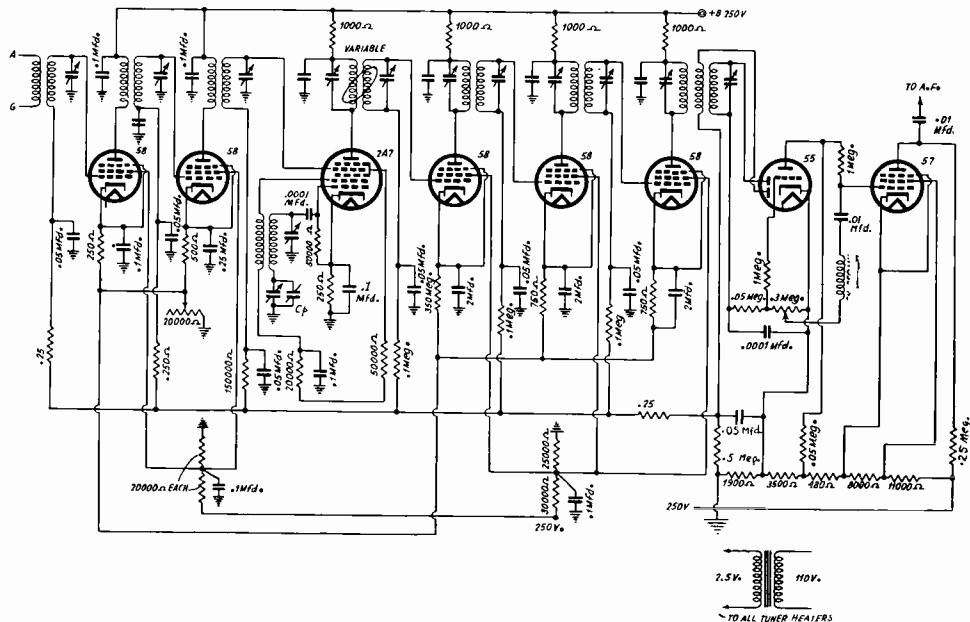

Here is the circuit as it stands today, the tuner permanently installed in the author's console, with a power amplifier. The amplifier diagram was presented on page 10 last month. Cp, the padding capacity, consists of a .0004 mfd. fixed condenser and 75 mmfd. air-dielectric trimmer across it.

How to Get Television

Circuit Requirements and Apparatus Revealed

By J. E. Anderson

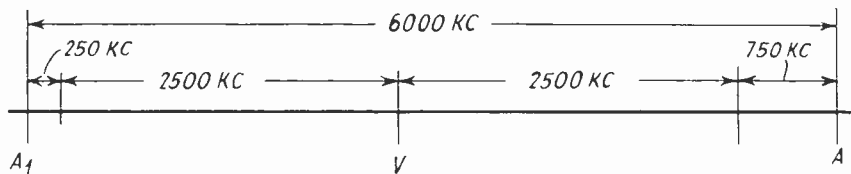

FIG. 1

This shows a tentative arrangement of television carriers in the frequency spectrum. V is the video carrier, A the audio carrier of the same composite channel, and A_1 is the audio carrier of the television channel next below.

INTENSIVE television research work is being done in many radio and optical laboratories, and encouraging progress is being made. If practical television does not arrive within a short time, it is not because the workers in the field are incompetent or laggard, but because of the inherent difficulty of the problems. Some of the accomplishments that have already been recorded are truly brilliant.

It seems that one of the practical steps that have to be taken before the achievements in television can be given to the public is to establish permanent standards. This is mainly a governmental task, although the authorities must be guided by the technical knowledge accumulated by research workers. Already there has been considerable progress in this direction, but nothing has been done that can be called final.

FACTORS TO BE STANDARDIZED

Some of the factors that must be standardized and definitely fixed are:

- The location of the television band in the radio spectrum
- The width of the television band
- The width of each television channel within the band
- The method of associating the picture and sound carriers in the television band
- The aspect ratio of the image, or the ratio between its width and its height
- The number of frames per second
- The number of lines per frame
- Whether the scanning is to be progressive or interlaced.

At present the recognized television band is from 42 to 86 megacycles except the band between 56 and 60 megacycles. The relative width of the band, therefore, in so far as tuning is concerned, is 2 to 1. In the near future this

band may be widened by extension upward, but any addition will probably not be great, because it is desirable to restrict the total range so that it can be covered with a single set of coils and with tuning condensers of small absolute value.

PRECAUTION AGAINST CLASHING

At present it appears that a television channel 6,000 kc wide will be satisfactory. Of this span, 5,000 kc will be devoted to the picture signal, allowing 2,500 kc for each video sideband, and the remainder will be devoted to the accompanying audio channel and the necessary guard bands, or safety zones. The guard bands are necessary to prevent clashing of sidebands of adjacent carriers, even when either of two such carriers strays a bit from its allotted spot in the radio spectrum.

The allocation of the sound and the picture carriers within the television band can be carried out in different ways. One simple way is to group all the audio carriers, suitably spaced, at one end of the band, and to group all the video carriers, also suitably spaced, at the other end. A second way is to alternate audio and video carriers throughout the band, always keeping together the two carriers which belong to the same composite television signal. The second method has been used experimentally, for it offers certain practical advantages. The first method requires two separate radio-frequency tuners, one for the sound and one for the picture, and these two cannot easily be ganged. The second method allows a single tuner of simple design, provided that the frequency separation between the associated audio and video carriers is the same for all channels. Practical considerations of tuning seem to demand such an arrangement. This method might be called the associative allocation

A diagram illustrating the associative allocation is given in Fig. 1. The horizontal line represents the frequency scale. The television channel extends from A_1 to A , a total span of 6,000 kc. The lower limit A_1 marks the location of the audio carrier for the television channel next below that under consideration. V , near the middle of the band considered, is the location of the video carrier, and A , at the upper end, is the location of the carrier of the sound accompanying V . Between A_1 and the nominal upper limit of the lower video sideband of V is a guard band of 250 kc, and between A and the nominal limit of the upper video sideband is a guard band of 750 kc. The purpose of these guard bands is to prevent clashing of the sidebands of the various carriers, those per-

frequency difference between the two carriers in the different television channels. In Fig. 1 this is 3,250 kc. This would be the same for any two associated carriers regardless of their location in the spectrum.

Suppose that V is 64,000 kc. Then A would be 67,500 kc. A single oscillation frequency would be used for beating these two frequencies down to the desired intermediate frequencies. The oscillator frequency should be higher than either V or A . Suppose the audio intermediate frequency is arbitrarily placed at 5,000 kc. The oscillator frequency would then have to be 72,250 kc. This would make the video intermediate frequency 8,250 kc.

In adjusting the oscillator, the tracking should be based on the audio signal, and the

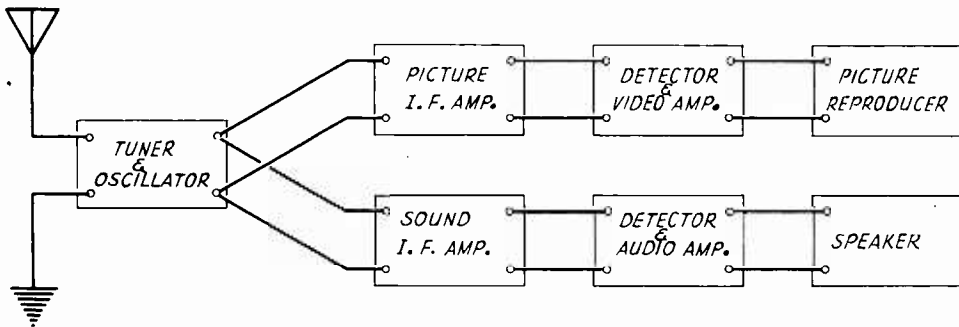

FIG. 2

Block diagram of a television receiver having both audio and video channel, both tuned with the same tuner. The first and common section contains only the high frequency oscillator and the radio frequency tuner.

taining to different signal groups as well as the two carriers of the same signal group.

It will be noticed that the upper guard band is three times wider than the lower. There are two reasons for this difference. First, A_1 and V belong to different signal systems, and A_1 is sufficiently suppressed by the radio-frequency tuner. A and V , on the other hand, belong to the same signal system, and the intermediate frequencies resulting from them exist side by side in the receiver, where they are amplified separately 10,000-fold or more. There is danger of mutual interference, especially as the tuners cannot be very sharp. It is particularly essential to prevent the audio signal from entering the video, as it might cause visual interference. It is for these reasons that the wide guard band is used between the two associated carriers.

RECEPTION PLAN

A block diagram of a television receiver is given in Fig. 2. At the extreme left is a tuner and oscillator. Beyond this there are two separate circuits. One contains a first detector, a picture intermediate frequency amplifier, a second detector, a video amplifier, and finally a picture reproducer, which may be cathode-ray tube with its auxiliary equipment. The other circuit contains the regular elements of a selective superheterodyne type receiver for sound, beginning with the first detector.

The main reason why a single tuner in the radio level can be used for tuning in both audio and video signals is that there is a constant

circuit as a whole should be tuned to that component. The reason for this is that the audio channel is as sharp as it is in any broadcast receiver, whereas the video channel is relatively broad. If the circuit is tuned precisely for the audio component, it is automatically tuned for the video, since the two are at a constant difference.

Intermediate frequencies of 5,000 and 8,000 kc seem very high, but in view of the magnitude of the ultra-high radio frequency carriers they are comparatively low. Anyway, they are necessary. Even the video intermediate frequency suggested is not large compared with the highest modulation frequency on it.

DOUBLE MODULATION

Another possibility of tuning in both the video and audio signals with a single tuner is to utilize double modulation and one ultra-high frequency carrier. The video signal is first impressed on one intermediate frequency and the audio signal on another. These two modulated frequencies are then impressed on the ultra-high carrier.

When this transmission is received, one high frequency tuner can be used, but from that point on everything must be in duplicate. When this system is used the transmitter determines the two intermediate frequencies and the receiver must duplicate them. Complications and difficulties in this scheme appear to be great.

(Continued on following page)

(Continued from preceding page)

Still another possibility is to impress the video signal directly on the high-frequency carrier and the audio as a part of the modulation. This requires elucidation.

Assume that the highest video frequency is 2,250 kc. Let another frequency of 3,000 kc be first modulated with the appropriate sound and then impressed on the high carrier together with the video signal. Each of the two sidebands will be 3,000 kc wide, but there will be a guard band of 750 kc between the highest nominal video frequency and the modulated carrier of the sound signal. The signal can be beaten down by means of an oscillator working at a frequency higher than the doubly modulated carrier by any suitable amount. The new composite carrier will have a modulation band 6,000

in the figure, and the capacitive coupling is obtained by taking advantage of the stray capacity between the two windings L_1 and L_2 .

The antenna is coupled directly to the first of the tuned circuits with the aid of a tiny condenser C_1 . Sufficient coupling may be obtained by merely placing the antenna lead close to the coil. That is, C_1 does not necessarily have to be a "formal" condenser. It will be remembered that the frequencies are ultra-high.

If the receiver is located in a place where the field strength is high, an indoor antenna is satisfactory, the effective length being about one-half wavelength. In places where the field strength of the television signals is weak, an outdoor antenna must be used. One of the Zeppelin type with a half-wave exposure is all right. An outdoor antenna must be used with

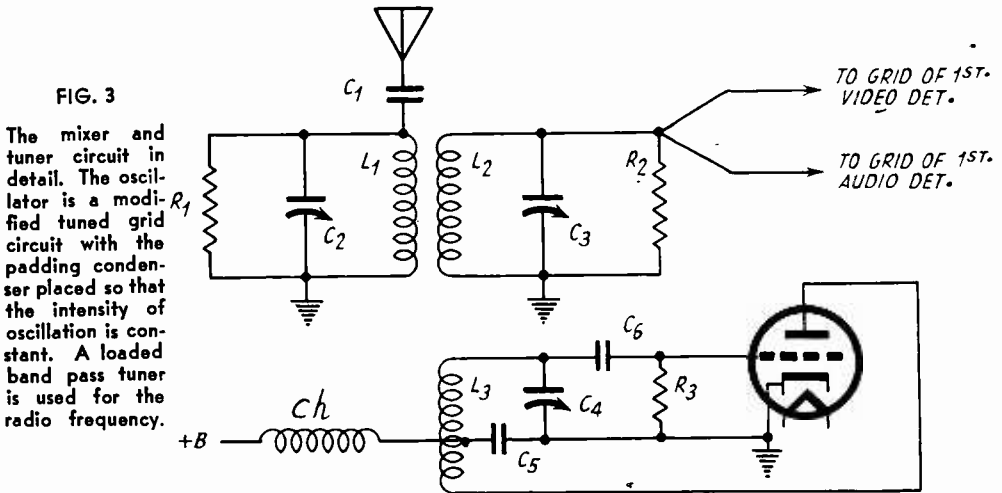

kc wide and therefore it must have a value much higher than 3,000 kc. That portion of the sideband which carries the sound can be segregated from the remainder by ordinary tuning and finally by detection. The video component can also be selected by means of another filter system. In this case there is good chance that there will be mutual interference between the sound and the picture. To prevent the sound from entering the video channel and being amplified, rejector circuits should be inserted in the video amplifier and tuned to the 3,000 kc carrier.

Although this double modulation method has the advantage of single tuning control, it either restricts the intermediate frequency to a particular value or demands double detection.

TUNER OSCILLATOR

In Fig 3 is a tuner circuit such as the one referred to previously. It has a so-called band-pass radio-frequency tuner in which both the primary and the secondary are tuned. A broad transmission characteristic is essential. This is obtained by combining capacitive and inductive coupling between the two circuits and by loading with resistances. These loading resistances and the mutual inductive coupling are indicated

a transmission line to conduct the signals to the tuner. A suitable line can be made of parallel wires spaced from one to two inches apart. If the antenna is directive and properly erected with reference to the location of the transmitting station to be received much better results can be expected.

NEARLY NON-REACTIVE

The oscillator with which the carrier frequency is stepped down is shown below the radio frequency in Fig. 3. L_3 is the oscillating coil and C_4 the variable condenser, which is part of the three-gang condenser used in the assembly. C_5 is the padding condenser. At the high-frequency end of the band the reactance of C_5 is so low that it can be disregarded, and it may then be assumed that C_4 alone is across the tuned portion of the tapped oscillator coil. At the low frequency end C_5 has the usual padding effect on the frequency. As C_5 is placed, it is effectively in series with the mutual inductance between the two parts of the coil, and since the mutual must be negative for oscillation, both the coupling reactances have the same sign. Their voltages add up. One reactance, however, is directly proportional to frequency and the other is inversely proportional,

The coupling, therefore, remains nearly constant throughout the tuning band of the oscillator, which makes the intensity of oscillation nearly independent of frequency. This is an advantage.

The coupling between the oscillator and the radio-frequency tuned circuits is a combination of mutual induction, stray capacity, and direct impedance.

The first two are obtained by placing the oscillator coil near the radio-frequency coils, and the direct coupling is obtained by placing a radio-frequency choke between the tap on the oscillator coil and the B supply. It is really the padding condenser that determines the direct coupling, for the choke is used only to prevent short-circuiting the condenser. The choke could also be connected directly to the plate without essentially changing the characteristics of the oscillator.

It is desirable that the resulting voltage across R_s should be directly proportional to the field strength at the antenna. The circuit in Fig 3 practically meets this requirement. Of course, the linearity should obtain for both of the components of the composite output of the frequency changer, that is, for both the video and audio elements.

AUDIO INTERMEDIATE AMPLIFIER

At R_s in Fig 3 the receiver divides into two parallel circuits, and, as indicated, the division is accomplished by connecting the high end of potential R_s to the grids of the two first detectors. The tubes of these detectors will be

shown in the audio and video intermediate amplifiers.

The audio intermediate amplifier contains six tubes, two of which are detectors and one an automatic volume control tube. It is diagrammed in Fig 4A. There are five doubly-tuned intermediate-frequency transformers, tuned of course to the high intermediate frequency selected for the sound channel. Previously we suggested 5,000 kc for the i.f. It may be higher or lower, but it is hardly practical to use one less than the highest broadcast frequency.

Since the intermediate frequency will be comparatively high, the circuits will not be very efficient. An overall gain of 10,000 should be sought. This requires three intermediate frequency tubes, all of which should be put on the automatic volume control, because large variations in signal strength can be expected, not only large from place to place, but large from one moment to the next.

It will be noticed that the first two amplifiers are given the full a.v.c. action while the third is given only about half of it. The permanent bias on the grids of the controlled tubes is 3 volts, since the grids are returned to minus 3 on the voltage divider and the cathodes are grounded. This voltage also serves to delay the a.v.c. action, for it is placed, with correct polarity, between the cathode of the rectifier tube and the anode of that tube. The signal voltage for the a.v.c. amplifier is taken from the grid of the third i.f. tube and is amplified and tuned additionally before it is rectified.

(Continued on following page)

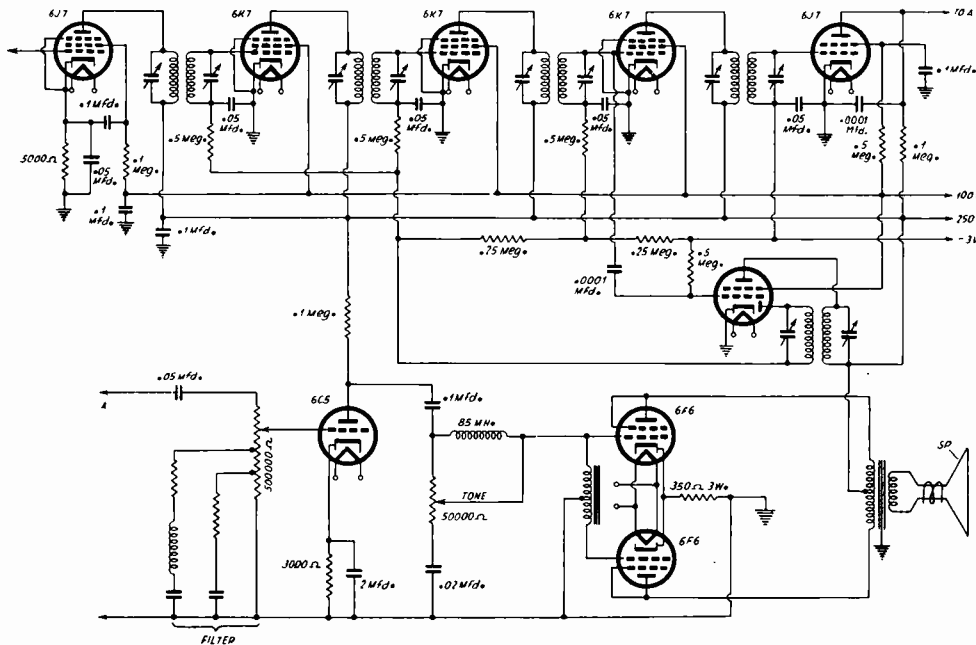

FIG. 4A

The audio channel from the first detector to the loudspeaker. Five doubly tuned intermediate transformers are used, all tuned to a frequency in excess of the highest broadcast frequency. Tone compensation is employed in the audio section. A.V.C. and manual volume controls are provided, as well as a tone control.

The grid circuit of the a-v-c tube is put in parallel with the grid of the last 6K7. The voltage thus picked up by the pentode is amplified and the resulting signal is delivered to a doubly-tuned intermediate amplifier and then to the diode rectifier. The entire negative voltage derived from the diode is impressed on the grids of the first two 6K7's, but only about half of it to the last 6K7. The two intermediate 6K7's, the second detector, a 6J7, and the first purely video tube, also a 6J7, are on a fixed grid bias of 3 volts, which is ob-

separated from each other before they can be used because they are to be impressed on three different tubes.

The first step in the separation is the removal of the strictly video component. This is accomplished by a circuit such as that given in Fig 5. The composite signal is impressed at A, across the high resistance R_1 . In series with this resistance is a grid battery C, which is connected so that it makes the grid of the tube positive by a considerable amount. In the grid lead is another high resistor R_2 , very large in comparison with the grid-cathode resistance of the tube as long as the grid is positive. Because of the limiting effect of R_2 , the plate current, as indicated by M, is practically constant. It is the saturation current of the circuit, not of the tube.

When the signal is large enough to overcome the positive bias applied, the grid becomes negative. The grid-to-cathode resistance of the tube then becomes infinite, and R_2 has no effect on the plate current. Therefore the space current follows the instantaneous value of the grid voltage. Suppose, for illustration, that the signal voltage is such as that shown about the vertical axis in Fig. 6. The jagged peaks on the right, or positive, side of the axis represent the picture component to be removed and the square-topped pulses to the left the synchronizing impulses, both the horizontal and the vertical. The upper part of the figure gives the grid voltage-plate current characteristic of the tube, together with the plate current resulting from the circuit in Fig. 5 and the signal voltage in Fig. 6. The current is constant except for sudden, deep drops coincident with the synchronizing pulses. These pulses, disencumbered of the picture component, can be utilized for synchronizing the scanning process.

SEPARATING THE IMPULSES

Before these pulses can be utilized, however, they must be run through another separator, one that sends the vertical synchronizing pulses one way and the horizontal syn-

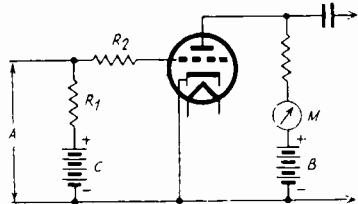

FIG. 5

A separator circuit for removing the picture component from the composite video signal, leaving the two synchronizing impulses.

tained from the power supply. This is not shown in this diagram. Since the load resistance of the rectifier also returns to 3 volts minus, there is a delay voltage on the rectifier of this value. The last video amplifier, the 6F6, is biased by a fixed amount of 20 volts, which also is obtained from the voltage divider in the B supply.

The video amplifier consists of only two tubes. This amplifier handles only the picture signal after the final detection. It is a direct-coupled circuit which can amplify impartially from the lowest video frequency, about 30 cycles per second, up to the highest, which is in the neighborhood of 2,500 kc. It is because of this enormous band that radio-frequency chokes have to be used in the plate circuits of the three tubes. The output of this amplifier is delivered to the grid of the cathode-ray tube, or of the kinescope.

The arrow connected to the plate of the second detector, which is marked "To sync.", leads to the synchronizing circuits to be described later.

The plate voltage supply for this section of the television equipment should be capable of delivering 250 volts and providing a screen voltage of 100 volts. It should also deliver negative grid voltages, measured with respect to ground, for the power tube, and the fixed bias for detectors and high-frequency amplifiers. The B supply should be preferably entirely separate from that supplying the audio channel. It is not given because any standard B supply may be used. The grid voltages should be adjustable for flexibility.

SEPARATION OF VIDEO IMPULSES

The output of the video channel, as in Fig. 4, contains three components: 1, the picture proper; 2, the vertical; and 3, the horizontal synchronizing components. These must be

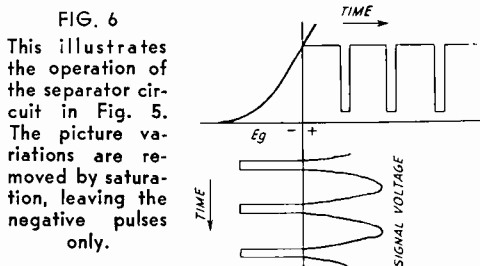

FIG. 6

This illustrates the operation of the separator circuit in Fig. 5. The picture variations are removed by saturation, leaving the negative pulses only.

chronizing pulses another. This separation is easily accomplished because of the wide frequency difference between the two sets of pulses, the frequency of the vertical impulses being 60 per second and that of the horizontal about 10,000 per second. These figures are based on 30 frames per second, 343 lines per frame, and two field repetitions per frame.

(Continued on following page)

(Continued from preceding page)

A circuit that will satisfactorily separate the two sets of pulses is given in Fig. 7. The composite signal as yielded by the circuit in Fig. 5 and illustrated in Fig. 6 is impressed on the grid circuit as usual. R_1 is a suitable plate coupling resistor in series with the voltage B , which may be either a battery or a well-filtered battery substitute. C_1 is a blocking condenser of very large size.

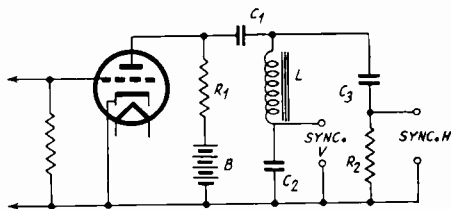

FIG. 7

A circuit for separating the two sets of synchronizing pulses. It consists essentially of one low pass filter and one high pass filter connected in parallel.

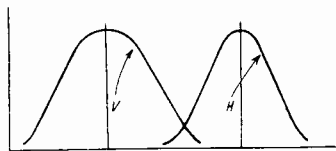

FIG. 8

Illustrative transmission characteristics of the circuit in Fig. 7. The peaks do not occur at their true relative distances apart.

The choke coil L prevents the high frequency horizontal impulses from reaching C_2 , but allows the low frequency vertical components to reach it without much attenuation. C_2 is a comparatively small condenser, so that it is charged to a high voltage quickly when the vertical synchronizing pulses come along. Two output posts marked "Sync. V," are provided for utilizing the impulses. Since there is no way in the circuit in Fig. 7 where the charges can leak off between the pulses, such a leakage path must be provided at the tube where the pulses are utilized.

PATH FOR PULSES

The horizontal synchronizing impulses find an easy path through C_2 and R_2 . C_2 is small enough to block the vertical synchronizing impulses and large enough to admit the horizontal synchronizing pulses without much attenuation. The horizontal pulses therefore appear across R_2 and are taken off at the posts marked "Sync. H."

The transmission characteristic of the separator in Fig. 7 is shown in Fig. 8. It is understood that the H-curve appears many times

higher up in the frequency scale than can be indicated in the drawing. Indeed, the ratio of H to V is about 343/2.

After the two sets of synchronizing impulses have been separated by the circuit in Fig. 7, they appear approximately as shown in Fig. 9. The horizontal pulses, H , rise suddenly to a sharp peak and then drop still more suddenly to a slightly negative value. In between the peaks the scanning lines are being drawn across the screen. The vertical synchronizing pulses, V , rise exponentially to a peak and then also die down exponentially. These pulses control the instants at which the discharge tubes break down and discharge the deflection pulses and thus terminate the horizontal lines and the frames, or the fields in case of multiple interlaced scanning.

There are various ways of producing the deflection voltages for the cathode ray tube. The device, to be satisfactory, should meet certain definite requirements. For the horizontal, the duration of the peak should be less than about 1/15 of the total duration of the cycle. For the vertical, the duration of



FIG. 9

At left are shown three pulses as obtained from "Sync. H." in Fig. 7 and at right one pulse as obtained from "Sync. V."

the peak should be less than about 1/80 of the total cycle. The circuit must be capable of synchronization and it should not have appreciable drift.

CONDENSER ACTION

One circuit that seems to meet these requirements is the blocking type oscillator, as shown in Fig. 10. As far as appearances go it differs in no respect from the ordinary

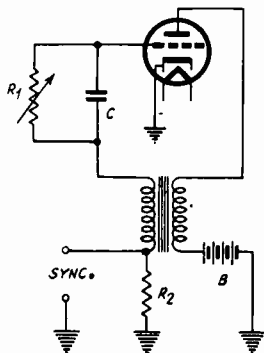

FIG. 10

A blocking type oscillator for producing saw-tooth deflection voltages, with provision for synchronizing pulses.

feedback oscillator. The difference lies in the choice of the constants of operation, particularly of the capacity of the grid condenser C and the total grid leakage resistance. The grid resistance should be adjustable, as R, Fig. 10, in order to vary the frequency of oscillation and the shape of the output curve. The synchronizing impulse, "sync.", is impressed across part of the grid leak resistance, R_s.

Another deflection voltage generator is shown in Fig. 11. DT is a gaseous discharge tube provided with a grid which determines the voltage of discharge. The condenser C is charged by battery B through resistance R. At a certain voltage across C and r, and hence across the plate, the plate circuit suddenly becomes conductive and rapidly discharges condenser C through the tube. The small resistance serves mainly to prevent a too rapid discharge of the condenser, and hence to prevent damage to the tube. The voltage across C at which the discharge occurs is determined by the value of the negative grid bias E_s. Since the time of charge and discharge is not dependable to the high degree accuracy required in a television system, it is necessary to utilize the synchronizing impulses to fix definitely the time of discharge. The discharge occurs sooner the lower the bias E_s is. Therefore the synchronizing signal is utilized to depress the grid voltage at the right instant. It is clear that if the synchronizing impulse is strong, E_s may be considerably higher than it would have to be if the synchronizing pulse were not used.

With special arrangements the outputs of either of the two deflection circuits can be made linear and saw-tooth. When the discharge tube is used the customary method of getting linearity is to charge the condenser C,

not at constant voltage B, but at constant current. This is done through a saturated diode or pentode.

DEFLECTION CIRCUIT ASSEMBLY

In Fig. 12 is shown an assembly of the various components of the deflection circuits. At the lower left, immediately following the

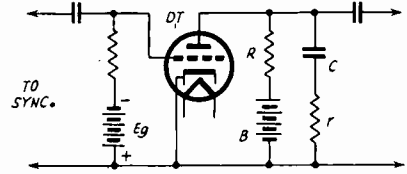

FIG. 11

A discharge type deflection oscillator in which a voltage is built up across a condenser and discharged through the tube.

picture amplifier, is the synchronizing separator circuit. The single tube, together with its grid and plate circuit networks, suppresses the picture component from the composite signal and then separates the two deflection impulses. The high frequency impulse is impressed on the horizontal deflection blocking oscillator at the upper right corner. This oscillator is followed by a three-tube amplifier and a network that makes the impulse linear. Finally the deflection voltage is impressed across the horizontal plates of the cathode ray tube, a transformer being used to step the pulses up to the required high value.

The low frequency synchronizing impulse is impressed on another blocking oscillator, directly to the right of the separator circuit.

(Continued on following page)

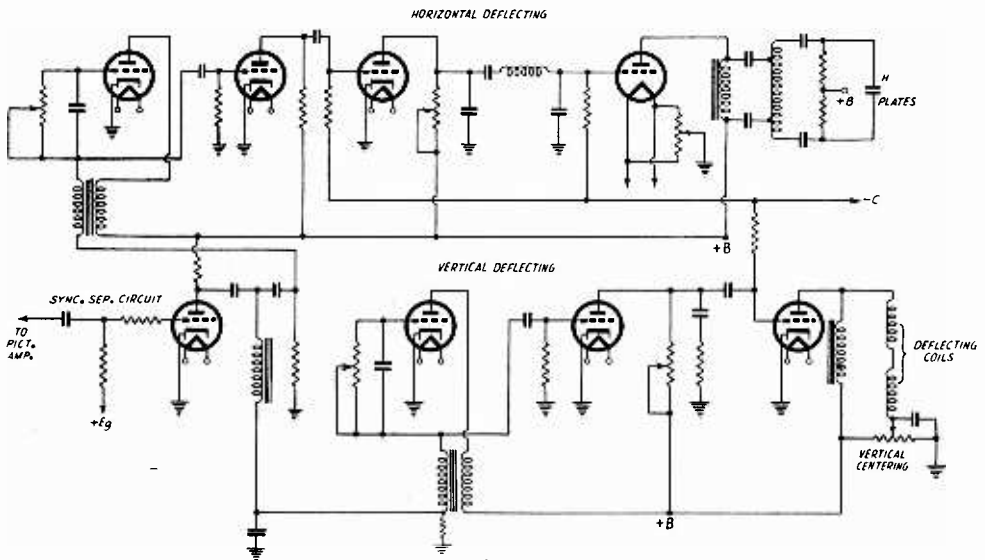

FIG. 12

A composite diagram of the various circuits and tubes required for the horizontal and vertical deflection impulses.

(Continued from preceding page)

This low frequency deflection oscillator is followed by a twostage amplifier the output of which is impressed on the deflection coils of a cathode ray tube. A vertical centering arrangement is associated with the output circuit of the vertical deflection circuit. A horizontal centering arrangement should also be provided. This is not shown because it is a simple circuit by means of which a potential bias can be applied to the horizontal plates, or to a pair of auxiliary horizontal plates.

It will be noticed that in this particular case the horizontal deflection is effected by means of a varying electric field, whereas the vertical deflection is accomplished by means of a magnetic field. This arrangement, of course, requires a cathode ray tube of a special type. Such tubes, however, are on the market.

REASON FOR MAGNETIC DEFLECTION

The reason magnetic deflection is used for vertical deflection is that electric deflection would require excessively high and dangerous voltages. A transformer is ineffective because of the low frequency involved. Electrostatic deflection can be used for the horizontal deflection because the frequency is much higher. The circuit in Fig 12 presumes a very large cathode ray tube in which great deflections are necessary. When the tube is smaller it is quite feasible to use electrostatic deflection for both the horizontal and the vertical impulses, and an arrangement of this kind would simplify the circuit greatly. Such simplified circuits will be shown in detail.

SIMPLE RECTIFIERS

A cathode-ray circuit that can be used with a television amplifier is shown in Fig. 13. This circuit differs from that of an oscilloscope only in the provision for applying a video signal on

the control grid in series with the fixed, though adjustable, bias. Of course, the deflection voltages must be linear and capable of synchronization.

The high direct voltage for the tube is provided by a separate rectifier and filter. Any type rectifier that will give 500 volts of well-filtered voltage will do. The diagram shows a half-wave rectifier, but it may also be of the voltage-doubling type. The current required is very small and there is no danger of overloading either type.

The filtering is also done very easily on account of the very small current drain. The drawing shows two 4 mfd. condensers and one 30 henry choke. The filtering would be good even if the choke and one of the condensers were omitted. But there is no harm in using the more thorough filtering indicated.

In choosing the parts for this filter and the rectifier it should be remembered that the mean voltage across the load resistor should be about 500 volts, and hence that peak voltages will be considerably higher. A voltmeter is indicated but it need not be wired into the circuit as a permanent fixture if easily accessible leads are provided where the voltage may be measured. Either a jack or a pair of insulated binding posts is logical.

CONSTANT SCREEN CURRENT

It will be noticed that the positive side of the output of the rectifier is grounded in this instance. This is done because of the desirability of grounding the case of the cathode-ray tube and the fact that the case is connected to the anode (No. 2). Two of the deflection plates, one plate of each pair, are connected to ground. Anode No. 1 is connected to the slider of a potentiometer which constitutes the middle section of the voltage divider resistance. In this case a 1 mfd. condenser is connected from this anode to the cathode because there will now be

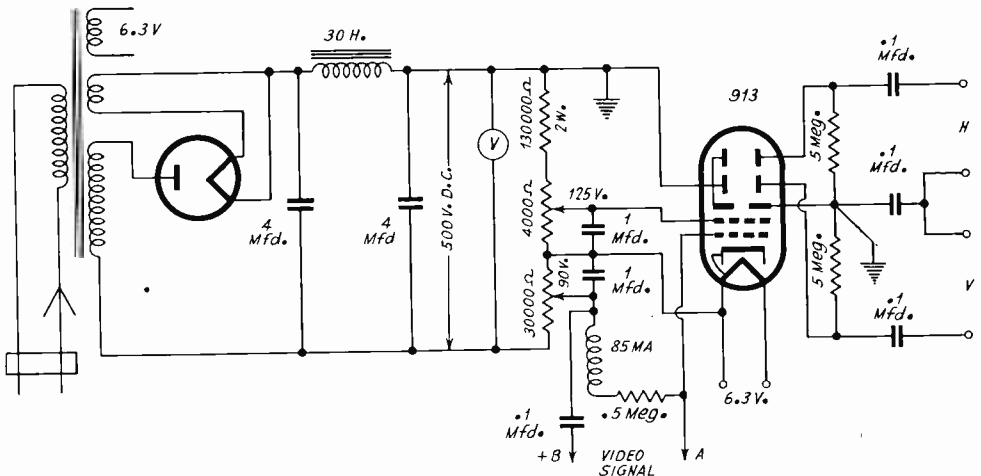

FIG. 13

A cathode ray circuit provided with its own power supply. The method of coupling it to the video signal source and to the time-impulses deflection voltage is indicated. The circuit is to be interpreted in conjunction with the previous figures referred in the text.

high-frequency currents present and it is desirable to maintain the screen voltage constant. For the same reason another one microfarad condenser is connected from the cathode to the grid return on the voltage divider. Provision is made for varying the biasing voltages on anode No. 1 and on the control grid.

The video signal, as obtained from the output of the last tube in Fig. 4B, is impressed on the cathode-ray control grid as indicated. Point A is connected to the plate side of the output and point B to the ground side. Since different points in the two circuits are grounded, care should be taken to see that the signal is not shorted out when the connection is made. A maximum fixed bias of 90 volts negative is indicated on the voltage divider. But the bias itself is subject to variation, and a potentiometer is provided for the purpose. The tube cuts off at about the indicated voltage. The fixed bias determines the mean brilliancy of the screen, or the mean intensity of the spot. The adjustment of the bias should be done with the object of getting greatest contrast. The video signal impressed across AB should be less in amplitude than the value of the negative bias, for it is necessary that the grid of the cathode-ray tube never be allowed to go positive.

DEFLECTION VOLTAGES

The deflection voltages are impressed at H and V. Their source might be a blocking type oscillator, as in Fig. 10, or a discharge oscillator, as in Fig. 11. The peak value of the deflection voltage on each plate of a 913 tube should be from 250 to 300 volts. If the sweep oscillators are capable of delivering this voltage it can be applied directly to the deflection plate terminals, but otherwise it has to be amplified, as has been done in Fig. 12. There is a grid-controlled, gaseous discharge tube, the 885, that will handle voltages as high as 400 volts, provided the negative bias on the grid is approximately one-tenth as great as the desired break-down voltage. That is, if the maximum voltage across C in Fig. 11 is to be 400 volts, the grid bias should be 40 volts. The discharge oscillator in Fig. 11 is not linear, but can be made so by charging C through a saturated pentode or diode. If no amplification is needed, the deflection terminals in Fig. 13 can be connected directly between the plate and cathode of the discharge tube. Only one stopping condenser is needed in the high potential line. Of course, two oscillators such as that in Fig. 11 should be used with the cathode-ray tube, and both should contain a synchronizing impulse as obtained from the circuit in Fig. 7. As was explained before, the synchronizing impulse is impressed on the discharge tube grid in series with the permanent bias in such a way that the grid potential is instantaneously depressed.

THREE INPUT VOLTAGES

There are three input voltages to the cathode-ray tube as shown in Fig. 13. The first is the video signal voltage, which is superposed on the bias of the control grid. This video contains the picture as well as the timing impulses. The second is the horizontal deflection voltage, im-

Television for Nation Is "Not Yet Ready," Board Tells Roosevelt

Washington.

Television is not ready for the public, according to the Federal Communications Commission in its annual report submitted recently to President Roosevelt and Congress. Following is the official statement of the Engineering Department in the Commission's report:

"While the technique of television has progressed during the past year, it seemed generally the consensus that television is not yet ready for public service on a national scale.

"There are numerous obstacles to be overcome and much technical development is required before television can be established on a sound national scale. Nevertheless, the rate of progress is rapid and the energies of the laboratories of the country are being concentrated on the technical development of television."

The Commission further reported rapid progress in development of facsimile communication and stated that the potentialities of facsimile service are of sufficient importance to require close attention to the results of experiments in application in commercial use.

pressed at H, and the third is the vertical timing deflection voltage, impressed at V. The deflection voltages are obtained from suitable saw-tooth oscillators, but contain the timing pulses diverted from the video signal. It should be remarked that it is not necessary to remove the timing pulses from the video signal before this is impressed on the control grid, because they always occur off frame. Indeed, it is of advantage to retain them, if they make the control grid negative, for then return traces will be so feeble that they cannot affect the appearance of the screen.

INTERLACED SCANNING

When the television image is scanned progressively, that is, in the same order as the lines of a book are read, there is considerable flicker. This is perceptible even when the frame is repeated as often as thirty times a second. To minimize this disagreeable effect, interlaced scanning has been tried. The simplest type of interlacing is illustrated in Fig. 14. Here lines are scanned alternately. Thus the first time the spot moves over the screen, it traces only the odd-numbered lines, 1, 3, 5, etc., as shown at A. When the last odd line has been completed, the spot jumps back to the upper left corner of the frame and repeats the scanning process, this time covering only the even-numbered lines, 2, 4, 6, etc., as shown at B. When the spot has traversed the screen twice in this

(Continued on following page)

(Continued from preceding page)

manner all the lines have been covered, and the scanning effect is as shown at C.

It is clear that when alternate interlaced scanning is used, the vertical scanning frequency must be twice as great as when progressive scanning is used, keeping the number of frames per second equal. It is also clear that the scanning equipment becomes complicated. The scanning spot does not return to the same place after each coverage. When the last odd line has been completed the spot jumps to the beginning of line 2, which is lower than the beginning of line 1. The difference is constant throughout the frame, and it can be brought about by means of a fixed bias. But this bias must be operative only when the scanning switches from odd to even lines, or vice versa, and not all the time. A means has been found for bringing about this type of vertical deflection.

NOT 100% ATTRACTIVE

The result of interlaced scanning is not all favorable. For example, if the observer views the screen closer than a given distance, the lines appear to squirm and wiggle and the phenomenon has been called the "worm effect." The reason for this effect is clear. The eye is affected most by the bright lines. At one instant the odd lines, in the immediate vicinity of the point of sharpest vision, are the brighter. At a small fraction of a second later the even lines are the brighter. Therefore there is an apparent shifting of the lines up and down. The effect disappears when the observer recedes from the screen to the point where the individual lines no longer can be seen separately. Therefore the effect is closely related to the resolving power of the eye.

When triple interlacing is used, the "worm effect" becomes more disagreeable, and for that reason, and because it complicates the scanning equipment still more, this form is not advocated by research workers in the field.

The scanning phase represented by either A or B in Fig. 14 is called a field. Their combined effect, as at C, is called a frame. This terminology has a definite and rational meaning when transmission takes place from a moving picture film, but it seems to be quite artificial when the transmission occurs from life.

According to the definition of the terms, the field frequency is twice as great as the frame frequency, if the dual interlacing method is used. If the triple method is used, the field frequency is three times as great as the frame frequency.

In view of the complications that interlacing entails, it does not appear that it would have any marked advantages over progressive scanning of somewhat higher frame frequency.

"Television Reception"— von Ardenne

The first book of considerable importance that deals constructionally with cathode-ray television, "Television Reception," by Manfred von Ardenne, presents an expert's view in simple and engaging style. The basic requirements of ultra-frequency television are set forth and discussed in logical order, with explicit and pointed determinations. It is obvious that from vast experimenting the author has culled the essentials and given the reader the full benefit of a discerning worker's excellent judgment.

For years von Ardenne has been experimenting with television in his native Germany. A year ago he published the present volume in German. The present volume is the first printing of an English translation, done by O. S. Puckle, of A. C. Cossor, Ltd., London, in a manner very satisfactory even to the author, who was educated in England.

Parts lists are included in the volume, faults in transmission and reception are cited, with remedies. Much that is printed has long been known, which is inevitable, yet much that is originally informative is included, which vests the volume with its highest interest.

The author has co-operated in the German government's television transmission and reception, and has confined to the pages of this 113-page book the expositions and suggestions most important to those desiring to experiment with reception of sight and sound on their own account.

The volume was printed in England and is published by D. Van Nostrand Company, Inc., New York City. It is generously illustrated with circuit diagrams and unretouched television photographs.

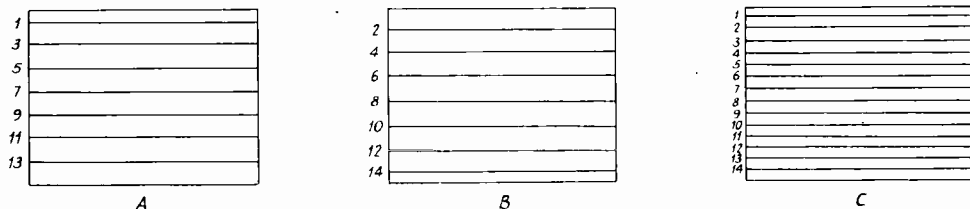

FIG. 14

These three fields illustrate the method of interlaced scanning. A, the first field in which all odd-numbered lines are traced. B, the second field in which all even-numbered lines are traced. C, the two fields combined into a complete frame.

Antenna Mysteries Explained

Neutralization Phenomenon and Wave Traps

By Carter English

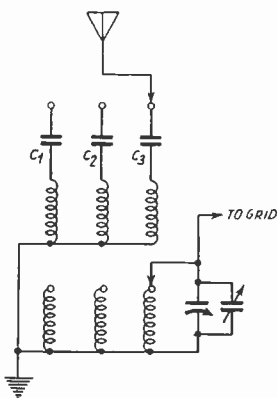

A series condenser for each band may be connected in the antenna circuit of an all-wave set. C1, C2 and C3 are the examples and are set once and left thus.

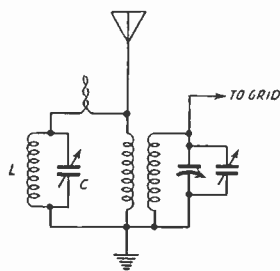

A parallel wave trap offers an excellent method of excluding one frequency. The trap consists of L and C. The few twisted turns of insulated wire provide coupling to the antenna circuit. This coupling must be very weak.

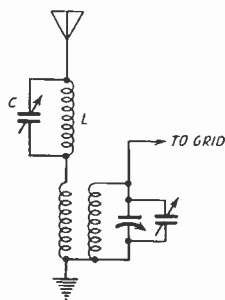

A series wave trap also is effective, but in general not quite as suitable as the other. Here C and L constitute the trap, which drops practically all the voltage of its natural period.

IF a very short antenna is used on a receiver that is sensitive enough to bring in a station audibly nevertheless, the capacity of the antenna will be small, also the pickup small, as it is nearly all capacitative. It is well known that the human body has capacity, too. The condenser effect between antenna and ground and that between body and ground is such that the voltage of a particular frequency may be of different phases across the two. Therefore if just enough capacity effect from the body is introduced it is possible to neutralize the effect of the antenna capacity, therefore prevent pickup, for the former antenna is now converted into a transmission line, which does not have any antenna effect. The coupling between the two must be equal and opposite in respect to the station carrier's voltage. A method of accomplishing small capacity effect is illustrated on the front cover photograph, taken by Herbert E. Hayden.

Another effect regarding antennas applies to all-wave sets. If small adjustable capacities are included in series with the antenna feed to each primary, the capacity may be adjusted for

some frequency in or near the middle of each band, determined by maximum response, and the set's overall efficiency for the band will be greatly increased and noise reduced. The diagram shows fixed condensers, for the variables are considered such, after their proper capacity has been established. It is not critical.

Wave traps often seem to many to be rather mysterious. There are two general types, the series and the parallel traps. Both operate on the theory that voltage of the frequency to which they are tuned will be completely dropped across them, hence any station of that frequency will be trapped out of the associated circuit, since none of the energy gets into the primary proper. The series trap is less attractive, as the coil L has some choking effect on other frequencies, and the capacity C may not be large enough to overcome this. The parallel trap, coupled to the antenna by a tiny capacity, as constituted for instance by a few turns of insulated wire, presents none of the impedance objections of the series trap, and will normally reduce the objectionable voltage more than 95 per cent.

MEASUREMENTS OF HEARING IMPROVED



Photos courtesy Bell Telephone "Record."

The young lady on the right is having her hearing tested by means of a new audiometer which is capable of making tests at any audio frequency up to 10,000 cycles.

TO enable ear specialists to diagnose ear ailments, to study the progress of ear diseases or courses of treatment, and to provide those suffering from deafness in different degrees with hearing aids, it is necessary to have instruments for measuring the extent of defects at different audio frequencies. Such devices are called audiometers. As may be seen from the photographs, these devices look about the same as radio sets, and, indeed, they are built of exactly the same parts. The essential feature of the instrument illustrated is a beat note oscillator the output of which can be controlled over a range from -15 to $+120$ db at any frequency from nearly zero up to 10,000 cycles.

Since some persons who cannot hear in the ordinary manner through the air are able to hear through bone conduction, an audiometer of widest usefulness must have provision for making both kinds of tests. Even when the patient hears a little through the air, a bone conduction test will aid the physician in diagnosing the trouble.

A feature in the audio beat oscillator of this device that is not found in other apparatus is the copper-oxide modulator for mixing the two frequencies, one of which is fixed at 100 kc and



The panel view of the audiometer together with earphones of which errors are automatically corrected in different frequencies.

the other of which varies between 100 and 10,000 cycles. This device not only reduces the cost of the apparatus but also allows more compact designs.

A microphone may be connected to the instrument in which the physician can talk directly to the receiver employed in the test. This is an optional feature.

The photographs illustrate apparatus engineered by the Bell Telephone Laboratories and manufactured by Western Electric.

HOW PITCH CHANGES WITH LOUDNESS OF SOUND

Most persons have been of the opinion that pitch and loudness are two independent characteristics of sound. Some text books on acoustics have fostered this impression. Yet it has been known for a long time that there is an interdependence, and musicians have observed the phenomenon. Recently this effect has been studied quantitatively in Bell Telephone Laboratories. As a result of the studies it has become clear that a pure tone, especially of a low frequency, cannot be specified by pitch alone, but that the intensity be specified simultaneously. Photograph illustrates an engineer determining the relationship between pitch and loudness.

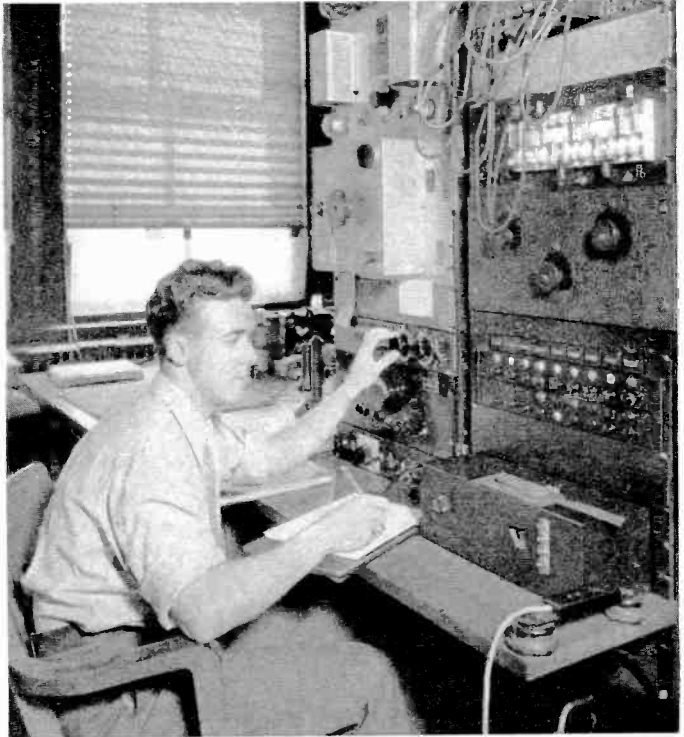

Index rings by means of taking readings at dif-

110 kc. The use of the apparatus but also

strument by means of a patient through the various advantage when needed by Bell Telephone Electric Co.

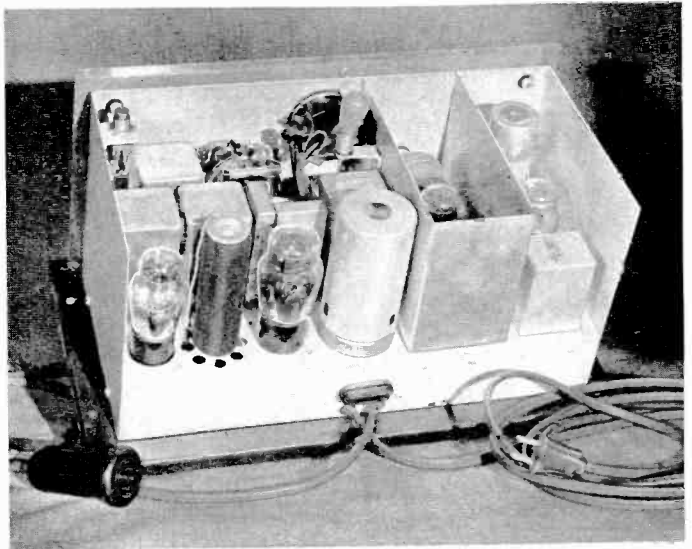

Rear view of the audiometer. All the parts are mounted on a metal chassis that fits as a unit in the outside box.

The Basic Formulas

Handy Grouping of Valuable Data

By J. E. Anderson

FREQUENCY

$$F \text{ cycles} = \frac{1}{2 \pi \sqrt{L_h C_r}} \dots (1a)$$

$$F_{kc} = \frac{159.2}{\sqrt{L \mu^h C \mu^f}} \dots (1b)$$

$$L_h = \frac{.02533}{C_r F_c^2} \dots (2a)$$

$$L_{\mu^h} = \frac{25330}{C_{\mu^f} F_{kc}^2} \dots (2b)$$

$$C_r = \frac{.02533}{L_h F_c^2} \dots (3a)$$

$$C_{\mu^f} = \frac{25330}{L_{\mu^h} F_{kc}^2} \dots (3b)$$

WAVELENGTH

$$v \text{ meters/sec.} = \lambda \text{ meters} \times F \text{ cycles/sec.} \dots (4a)$$

$$F_{Mc} = \frac{300}{\lambda_{meters}} \dots (4b)$$

$$\lambda_{meters} = \frac{300}{F_{Mc}} \dots (4c)$$

$$\lambda_{meters} = 1884 \sqrt{\frac{L \mu^h C \mu^f}{\mu^h \mu^f}} \dots (5a)$$

$$\lambda_{meters} = 1.884 \sqrt{\frac{L \mu^h C \mu^f}{\mu^h \mu^f}} \dots (5b)$$

SERIES (s) AND PARALLEL (p) CONNECTIONS

$$R_s = R_1 + R_2 + R_3 + \dots \dots (6a)$$

$$L_s = L_1 + L_2 + L_3 + \dots \dots (6b)$$

$$C_p = \frac{C_1 C_2}{C_1 + C_2} \text{ (for 2 only)} \dots (6c)$$

$$R_p = \frac{R_1 R_2}{R_1 + R_2} \text{ (for 2 only)} \dots (7a)$$

$$L_p = \frac{L_1 L_2}{L_1 + L_2} \text{ (for 2 only)} \dots (7b)$$

$$C_p = C_1 + C_2 + C_3 + \dots \dots (7c)$$

REACTANCE AND IMPEDANCE

Units: Ohms

$$X_L = 2 \pi F_{cy} L_h \dots (8a)$$

$$X_C = \frac{1}{2 \pi F_{cy} C_r} \dots (8b)$$

$$X = X_L - X_C \dots (8c)$$

$$z = R + j X \dots (8d)$$

$$Z = \sqrt{R^2 + X^2} \dots (8e)$$

$$\text{For resonance, } X = 0 \dots (8f)$$

OHM'S LAW

Units: Ohms, Amperes, Volts, Henries, Farads, Cycles/sec., Watts.

$$E = ZI \dots (9a)$$

$$E = RI \dots (9b)$$

$$I = \frac{E}{R} \dots (9c)$$

$$R = \frac{E}{I} \dots (9d)$$

$$f = 2 \pi FC \dots (9e)$$

$$I = \frac{E}{2 \pi FL} \dots (9f)$$

$$I_r = \frac{E}{Z_r} = \frac{E}{R} \text{ (} X = 0 \text{)} \dots (9g)$$

$$P_{watts} = E_{volts} \times I_{amp} \dots (9h)$$

$$P = EI = I^2 R = \frac{E^2}{R} \dots (9i)$$

(Continued on page 38)

**C
U
R
V
E

F
O
R

E
X
T
R
A
C
T
I
N
G

S
Q
U
A
R
E

R
O
O
T
S**

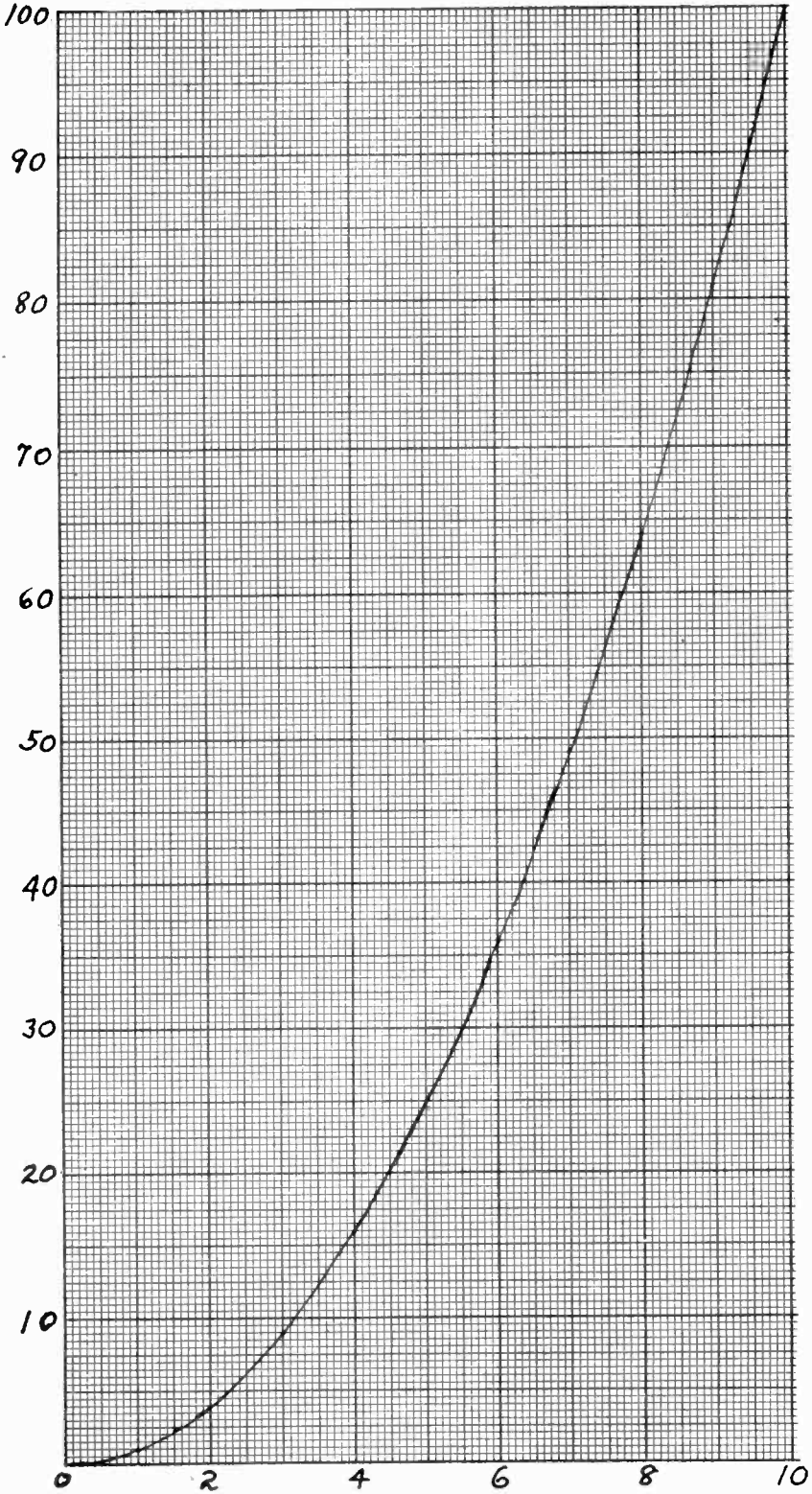

(Continued from page 36)

ATTENUATION

$$N(\text{db}) = 10 \log_{10} \left(\frac{P}{P_o} \right)$$

$$= 20 \log_{10} \left(\frac{V}{V_o} \right)$$

$$= 20 \log_{10} \left(\frac{I}{I_o} \right)$$

Above is for power (10a)

$$N(\text{db}) = 10 \log_{10} \frac{V}{V_o} \text{ (for volts) (10b)}$$

$$N(\text{db}) = 10 \log_{10} \frac{I}{I_o} \text{ (for currents) (10c)}$$

BRIDGE BALANCE

Z₁, Z₂, Z₃ and Z₄ are four general impedances in a bridge circuit, in which Z₁ and Z₂ are in one branch and Z₃ and Z₄ in the other. Z₁ and Z₃ are adjacent at one vertex and Z₂ and Z₄ at the other.

RESISTANCE BALANCE

$$\frac{R_1}{R_2} = \frac{R_3}{R_4} \text{ (11a)}$$

REACTANCE BALANCE

$$\frac{X_1}{X_2} = \frac{X_3}{X_4} \text{ (11b)}$$

COMPLETE BALANCE

$$\frac{Z_1}{Z_2} = \frac{Z_3}{Z_4} \text{ (11c)}$$

CHARACTERISTICS OF TUBES

$$\mu = \frac{d e_p}{d e_g} \text{ (} i_p \text{ constant) (12a)}$$

$$g_m = \frac{\mu}{r_p} = \frac{d i_p}{d e_g} \text{ (12b)}$$

$$r_p = \frac{d e_p}{d i_p} \text{ (12c)}$$

The "d" in these formulas denotes differential, or small variation in the quantity following. Thus dE is a small change in E. dE/dI is understood to mean the ratio of a small change in E resulting from a given small change in I. Similarly for the formulas (12).

TWO-POINT OSCILLATOR PADDING

- F₁, lower tie-down frequency.
- F₂, upper die-down frequency.
- f, intermediate frequency.
- L_o, oscillator inductance.
- L, radio frequency inductance.
- K, series padding capacity.

The minimum capacities in the oscillator and radio frequency circuits at F₂ are assumed to be equal.

$$L_o = L F_2^2 / [F_2 + f]^2 \text{ (13)}$$

$$.02533$$

$$K = \frac{\mu^2}{L_o (F_1 + f)^2 - L F_1^2} \text{ (14)}$$

Inductances in microhenries and frequencies in megacycles.

KIRCHHOFF'S LAWS

First Law: The sum of all the currents flowing to a point in a network is equal to the sum of all the currents flowing away from the point. If currents flowing to the point are positive and currents flowing away are negative, then the law may be expressed symbolically: $\sum I_i = 0$ (15) which reads, the summation of all currents flowing to a point is zero. The first law simply states the fact that current cannot pile up at any point.

Second Law: In any electrical circuit, the sum of the electromotive forces is equal to the algebraic sum of all the voltage drops in that circuit. Voltage drops as well as electromotive forces must be taken with their proper signs.

DEFINITIONS

A direct current is one that flows in the same direction all the time.

A direct current is steady or invariable if it has the same value all the time.

An alternating current is one that flows alternately in both directions.

A pulsating current is a direct current that has an alternating current superimposed, or which flows in unidirectional pulses.

A variable current is either an alternating or a pulsating current.

The instantaneous value of a variable current is the value it has at a given instant.

The effective value of a variable current is a measure of the heating effect of that current in a pure resistor. The effective value of an invariable direct current is the same as the steady value of that current.

A variable current and a steady current are said to be equal when they produce the same heat in equal resistances in equal time.

The effective value of a variable current is the square root of the sum of the squares of the instantaneous values of current taken over equal infinitesimal increments of time. This is also called the root mean square (rms) value of the current. For a pure sinusoidal alternating current the rms value is .707 of the maximum value of that current.

(Continued on page 40)

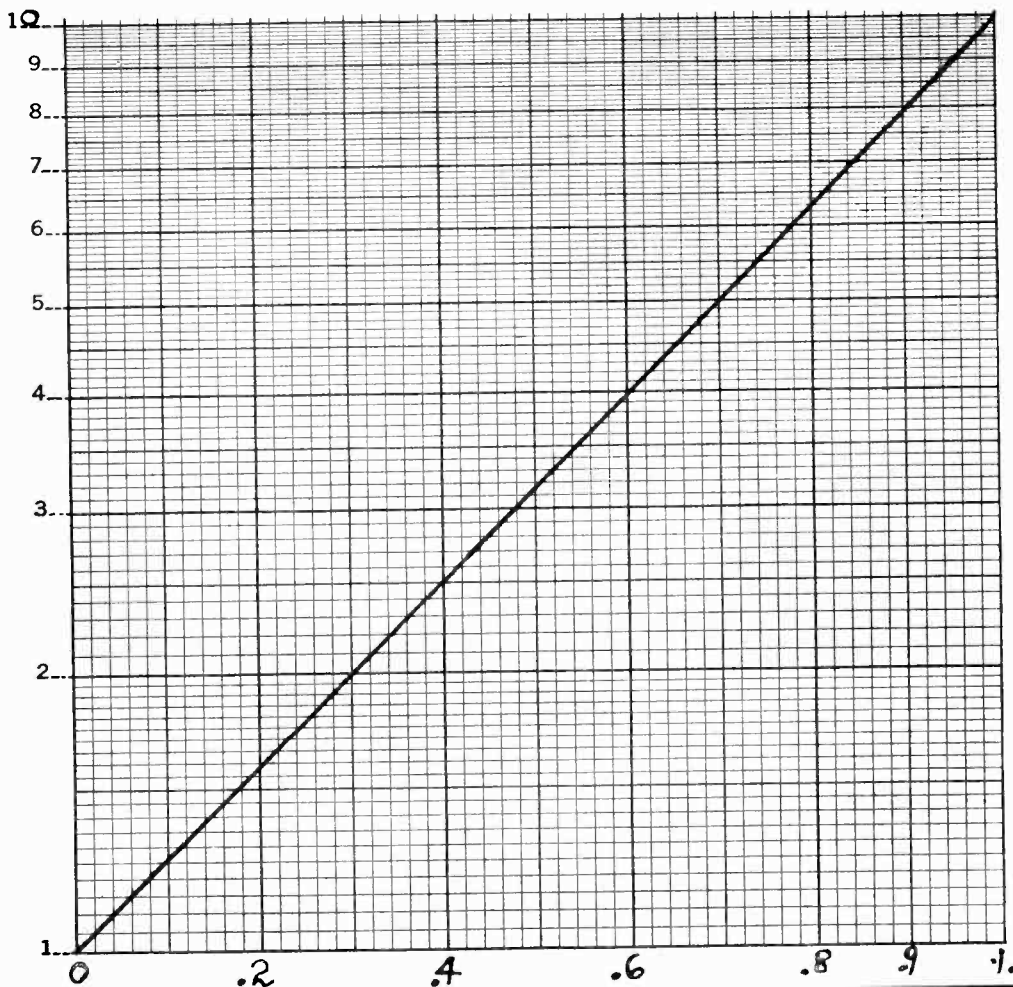

Get Logarithms by Consulting Curve

The logarithm curve extends only from 1 to 10, and within these limits the logarithm is fractional. This fraction is called the mantissa of the logarithm. As it is written in tables, the mantissa is always positive even though the logarithm may be negative. The mantissa of a number depends on the sequence of the digits and not on the location of the decimal point. Thus the numbers 500, 5 and .05 all have the same mantissa, namely, .699. Because of this, the curve can be used for finding the logarithm of any number.

For numbers greater than 10 the decimal point is moved to the left until the number falls between 1 and 10. The whole number of the logarithm, called the characteristic, is then equal to the number of places the decimal point has been moved. Thus if the number is 500, the characteristic is 2 because the point must be moved two places to the left to bring the number between 1 and 10. The complete logarithm of 500 is then 2.699.

If the number is less than 1, the decimal point is moved to the right until the number lies between 1 and 10. The characteristic is again equal to the number of places the decimal point has been moved, but this time it is negative. Thus suppose that the number is .07. The decimal point must be moved two places to the right to bring the number within the range of the curve. Therefore the characteristic is -2 . The curve gives .846 for the mantissa of 7. Therefore the total logarithm is $-2 + .846$. In tables this is written 2.846 with a minus sign over the characteristic, for it applies only to that part. This is the way the negative logarithm is written when it is used for division and multiplication. When it is required by itself it is written -1.154 .

(Continued from page 38)

WHAT "MEAN VALUE" IS

The mean value of a variable current is the average of all the instantaneous values of the current taken over equal infinitesimal increments of time. If the current is unidirectional, the mean value is read on a direct current meter. The mean value of a purely sinusoidal current is .636 of the maximum value. The ratio of the effective and the mean values is therefore 707/636, or 1.111. This is called the form factor. Currents which are not pure sinusoids have different form factors.

A hot wire type ammeter measures the effective value of a current whether it is direct or alternating.

Voltages, like currents, can have instantaneous, average, and root mean square values, and they can be direct, alternating, pulsating direct, and variable. In this connection, voltages are thought of in reference to the type of current they will drive through a pure resistance of specified value, for the effective value of a voltage cannot be defined in terms of its heating effect, since it has no heating effect.

POWER FACTOR

When an alternating current flows through a circuit having reactance the current is out of phase with the voltage, that is, corresponding values of voltage and current do not occur at the same time. If the reactance is predominantly inductive, the current lags behind the voltage; if it is predominantly capacitive, the current leads the voltage. The time expressed in electrical degrees is called the phase angle, or the angle of lag or of lead, as the case may be. The useful power in such a circuit is not the product of the voltage and the current, but this product multiplied by the cosine of the phase angle. This cosine is called the power factor of the circuit. In a commercial power circuit this factor should be as near unity as possible. In a tuned circuit it should be as small as possible.

If P is the power in watts, E the effective voltage in volts, I the effective current in amperes, and ϕ the phase angle, then $P = EI \cos \phi$ is the useful power. The other power involved, $P_1 = EI \sin \phi$, is called wattless. It is the impotent component for it surges back and forth without accomplishing anything. In a tuned circuit intended for frequency discrimination the impotent component should be as large as possible.

$$\cos \phi = \frac{R}{Z} \dots\dots\dots (16a)$$

$$\sin \phi = \frac{X}{Z} \dots\dots\dots (16b)$$

$$\tan \phi = \frac{X}{R} \dots\dots\dots (16c)$$

$$Q = \frac{2 \pi F_r L}{R} \dots\dots\dots (17a)$$

$$\tan \phi = Q \left(\frac{F}{F_r} - \frac{F_r}{F} \right) \dots\dots\dots (17b)$$

in which F_r is the frequency of resonance.

FORMULA DEFINING DECUREMENT

The decrement of a freely oscillating circuit is defined by

$$\delta \text{ (delta)} = R/2F_r L \dots\dots\dots (18a)$$

whence with (17a)

$$\delta = \pi/Q \dots\dots\dots (18b)$$

The decrement is the rate at which free oscillations die down in a circuit.

Equation 17b contains a definition of the Q of a circuit that is useful in measuring this important constant. First tune the circuit to exact resonance and let the current in the circuit be I_r . Detune the circuit by varying the frequency until the current reads .707 I_r , or until the deflection of a thermogalvanometer reads .5 of the resonance deflection. When this condition obtains the tangent of the phase angle, $\tan \phi$, is either -1 or 1, depending on whether the new frequency is less or greater than the frequency of resonance. Thus we have

$$Q \left(\frac{F}{F_r} - \frac{F_r}{F} \right) = \mp 1 \dots\dots\dots (17c)$$

Thus if F_r and F are observed accurately for the two stated conditions Q can be computed. For most accurate results two determinations should be made, one by detuning downward and one by detuning upward, and then taking the average of the tube.

SIMPLIFICATION INTRODUCED

This averaging can be done analytically with a great simplification in the formula and the computation. Let F_2 be the higher and F_1 the lower frequency at which the current is .707 I_r , or the deflection is $D = .5 D_r$ on a current squared meter, then 17c can be written

$$\begin{aligned} Q(F_2^2 - F_r^2) &= F_2 F_r \} \\ Q(F_1^2 - F_r^2) &= F_1 F_r \} \dots\dots\dots (17d) \end{aligned}$$

By subtracting the second from the first and reducing the result is

$$Q = \frac{F_r}{F_2 - F_1} = \frac{F_r}{f} \dots\dots\dots (17e)$$

where f is the difference between F_2 and F_1 . In words this says that the Q of the circuit is equal to the frequency of resonance divided by the

difference between the two frequencies at which the current is .707 of the current at resonance.

When the frequency of resonance is high and the circuit is selective, the difference frequency will be small compared with either of the two frequencies. Large errors, therefore, are likely to creep into the measured value unless the calibration is such that the frequencies can be read with high accuracy.

The frequency of a freely oscillating circuit is lower than the natural frequency of the same circuit when it is driven, and it is lower the higher the resistance in the circuit. If L is the inductance, C the capacity, and R the resistance in the circuit, then

$$F_r = F_0 \left(1 - \frac{R^2 C}{4L} \right)^{1/2} \dots \dots \dots (19a)$$

in which F_r is the actual and F_0 driven natural frequency or the frequency when the resistance is zero. When the resistance is small and L and C have reasonable values, (19a) may be written

$$F_r = F_0 \left(1 - \frac{R^2 C}{8L} \right) \dots \dots \dots (19b)$$

HARMONICS

$$F_x = nF_1 \dots \dots \dots (20a)$$

where F_x is the unknown high frequency, and n is the harmonic order of F_1 . Both n and F_1 must be known.

If only fundamentals are known, and harmonics used for zero beating with F_x , at least two low frequencies, F_2 and F_1 , must be known. Then

$$F_x = \frac{F_1 F_2}{F_2 - F_1} \dots \dots \dots (20b)$$

where F_x is the unknown high frequency, F_1 and F_2 are the low frequencies related to F_x by harmonics, and responses in the receiver are consecutive. If more than two responses are used, the total number is counted, the terminal low frequencies noted, and

$$F_x = \left(\frac{F_1 F_2}{F_2 - F_1} \right) (n - 1) \dots \dots \dots (20c)$$

where n is the total number of responses.

The harmonic orders may be obtained by dividing F_x by the low frequency.

$$m = \frac{F_x}{F_2} \dots \dots \dots (20d) \quad n = \frac{F_x}{F_1} \dots \dots \dots (20e)$$

$$\frac{F_x}{F_2 + F_1} \div (F_2 - F_1) = m + n$$

$$m = \left(\frac{s + n}{2} \right) - 1 \dots \dots (20f)$$

$$n = \left(\frac{s + n}{2} \right) + 1 \dots \dots (20g)$$

where m is the lower harmonic order, n the higher, and F_2 is higher than F_1 ; $s = F_2 + F_1$.

Since the harmonic orders are absolute and F_x is considered likewise, accuracy is improved by using harmonic orders for finding F_x . First find the harmonic orders as follows:

$$m = F_1 \div (F_2 - F_1) \dots \dots \dots (20h)$$

$$n = F_2 \div (F_2 - F_1) \dots \dots \dots (20i)$$

from which it can be seen the harmonic orders are ascertained by an inverse process, the numerator being F_1 , the harmonic order m of F_2 is obtained, and for F_2 numerator the harmonic order of F_1 is derived.

Also the unknown is the product of the harmonic orders and the difference:

$$F_x = m \times n \times (F_2 - F_1) \dots \dots \dots (20j)$$

the accuracy of which is limited by the closeness to zero beat that one may come, as the result becomes self-checking, since only two particular frequencies can exist for consecutive responses. Then F_x may be computed from the close empirical values to an even greater accuracy, normally better than .01 per cent.

The distributed capacity of a coil, or the minimum capacity of a coil in a circuit, can be measured by means of harmonics. An oscillator rich in harmonics is desirable, or else an oscillator and a harmonic producer. The circuit in which the coil is connected is tuned to resonance with any convenient frequency, which may be a harmonic of the fundamental of the oscillator frequency. The oscillator is then left undisturbed while the circuit is tuned, with the condenser in it, until another response is noted. If the harmonics involved are known, the minimum capacity can be computed. Let F be the fundamental frequency of the oscillator, m the harmonic of F at the first observation, and n the harmonic of F at the second observation. Also let C_m and C_n be the readings of the calibrated condenser when the maxima occur and let C_0 be the distributed capacity sought. Then it can be shown that

$$C_0 = \frac{m^2 C_m - n^2 C_n}{n^2 - m^2} \dots \dots \dots (21a)$$

Special Cases.

$$m = 1 \quad n = 2 \dots \dots C_0 = \frac{C_1 - 4C_2}{3} \dots \dots (21b)$$

$$m = 1, \quad n = 3 \dots \dots C_0 = \frac{C_1 - 9C_3}{8} \dots \dots (21c)$$

$$m = 2, \quad n = 3 \dots \dots C_0 = .8C_2 - 1.8C_3 \dots \dots (21d)$$

Capacity in terms of frequency and inductance, .02533

$$C = \frac{F^2 L}{.02533} \dots \dots \dots (22a)$$

If $L = 253.3$ microhenries and if the frequency is expressed in megacycles,

$$C = \frac{100}{F^2} \mu\mu F \dots \dots \dots (22a)$$

If $L = 2.533$ millihenries and if the frequency is expressed in kilocycles,

$$C = \frac{10}{F^2} \mu F \dots \dots \dots (22c)$$

(Continued on following page)

(Continued from preceding page)

Inductance in terms of frequency and capacity,

$$L = \frac{.02533}{F^2 C} \dots\dots\dots (22d)$$

If C = 253.3 micromicrofarads and if the frequency is expressed in megacycles,

$$L = \frac{100}{F^2} \mu H \dots\dots\dots (22c)$$

If C is .02533 mfd. and the frequency is expressed in kilocycles,

$$L = \frac{1}{F^2} \text{ henries} \dots\dots\dots (22f)$$

If C is .02533 mfd. and the frequency is expressed in megacycles,

$$L = \frac{1}{F^2} \text{ microhenries} \dots\dots\dots (22g)$$

If L is expressed in microhenries and F is 159.2 kilocycles,

$$C = \frac{1}{L} \mu F \dots\dots\dots (22h)$$

If C is expressed in microfarads and F is 159.2 kilocycles,

$$L = \frac{1}{C} \mu H \dots\dots\dots (22i)$$

If the wavelength is measured in centimeters and the capacity in micromicrofarads and if the inductance is 2.814 millihenries, then

$$C_2 - C_1 = \lambda_2^2 - \lambda_1^2 \dots\dots\dots (23a)$$

the distributed capacity in the circuit being eliminated by the two observations. If the wavelength is given in meters and the inductance is .2814 microhenries, then

$$C_2 - C_1 = \lambda_2^2 - \lambda_1^2 \dots\dots\dots (23b)$$

If ΔC is the small change in C which will just offset a small change ΔL in L, then

$$\frac{\Delta C}{C} = \frac{\Delta L}{L} \dots\dots\dots (24a)$$

the circuit being tuned to zero beat both times. Thus a very small inductance ΔL can be measured.

INDUCTANCE EXAMPLES

If F is measured in megacycles, C_2 and C_1 in micromicrofarads, and L in microhenries, and if C_2 is the capacity needed for tuning in the fundamental and C_1 the second harmonic, then

$$L = \frac{19,000}{F^2 (C_2 - C_1)} \dots\dots\dots (25)$$

If two inductance coils are connected in series, the inductance of the combination is

$$L_a = L_1 + 2M + L_2$$

$$L_b = L_1 + 2M + L_2 \dots\dots\dots (26)$$

By measuring L_a and L_b separately, the mutual inductance M can be obtained with the formula

$$M = \frac{L_a - L_b}{4} \dots\dots\dots (27)$$

The inductance of a solenoid is

$$L = .1a^2 n^2 N K \dots\dots\dots (28)$$

L is given in microhenries if a is the radius of the coil in inches, n is the total number of turns, N is the number of turns per inch, and K is a constant depending on the ratio of the length of the winding to the diameter. This constant is found in tables published in "The Inductance Authority."

RESISTANCE MEASUREMENT

A large resistor can be measured in terms of the known resistance of a voltmeter. Let R_m be the known resistance of the voltmeter, R the unknown resistance to be measured. Connect R in series with the meter and with a battery of suitable voltage. Let the voltage reading on the meter be V when the unknown is in the circuit. Let it be E when R is shorted. Then $R = R_m (E/V - 1) \dots\dots\dots (29)$

A small unknown resistance can be measured in terms of the known internal resistance of a milliammeter. The meter is connected in series with a very high resistance and a battery which will drive a suitable current through the meter, near full scale. The unknown resistance is then connected in shunt with the milliammeter terminals. The change in the total current flowing is negligible but the change in the meter reading may be large because part of the total current goes through the shunt and part through the meter. If R_m is the internal resistance of the meter, R the unknown resistance connected in shunt, I_0 the meter reading without the shunt and I_m the reading with the shunt, then

$$R = \frac{R_m}{I_0/I_m - 1} \dots\dots\dots (30)$$

Literature Wanted

- Evans Daggett, 281 Washington St., Keene, N. H.
- Anthony G. Farrell, 54 Gaines Place, Rensselaer, N. Y.
- Olaf Berquist, 613 Garfield St., Eveleth, Minn.
- Ernest Marshall, 104 Garfield Ave., Endicott, N. Y.
- Virgil Gaught, Robinson, Ill.
- Radio Dept., Ace Photos, Treichlers, Penna.
- Daniel A. Holler, 318 Spruce St., Westernport, Md.
- Russell R. Cool, 210 E. 25th St., Wilmington, Del.
- M. C. Dillon, R.F.D. No. 4, Box 84, Hamilton, Ohio—long and short wave kits, parts, etc., also service equipment, and public address.
- Georges Moens—SURO (ON4), Box 254, Cairo, Egypt.
- Frank Pearcey, M.D., 471 Park Ave., New York, N. Y.
- Wm. Handley, Box 401 Helmhuth, N. Y.
- Walter Broshar, Jr., 2332 Noble St., Anderson, Ind.
- Richard Dawson, 1308 F St., The Dallas, Oregon.
- Leander G. Logan, Cheyney Training School, Cheyney, Penna.
- Daniel Patterson, P. O. Box No. 125, Loami, Ill.—Radio repair parts.
- Ed. Templin, 403 Linden Walk, Lexington, Ky.—Particularly parts for amateur short wave Xmitter.
- Q. R. Danner, 831 Roosevelt Ave., Seacaucus, N. J.
- Hilton Adams, Certified Radiotrician, NRI-750 N. Belleview Ply., Indianapolis, Ind.
- M. J. MacLean, 38 Cossitt Str., Sydney, C. B., N. S.
- Canada—Tube data, meter and test equipment and general radio parts, booklets, etc.
- E. S. Carter, 1328 Crane St., Schenectady, N. Y.
- W. H. Snyder, Quality Radio Products, Richmond, Ind.
- Edward Schickram, Akron, Penna.
- Mogell, 1944 Boston Road, New York, N. Y.
- Popma Radio Service, Orange City, Iowa.
- Dave Cern, 4685 Montcalm, Detroit, Mich.
- Robert Denmark, 2876 Jerome Ave., New York, N. Y.

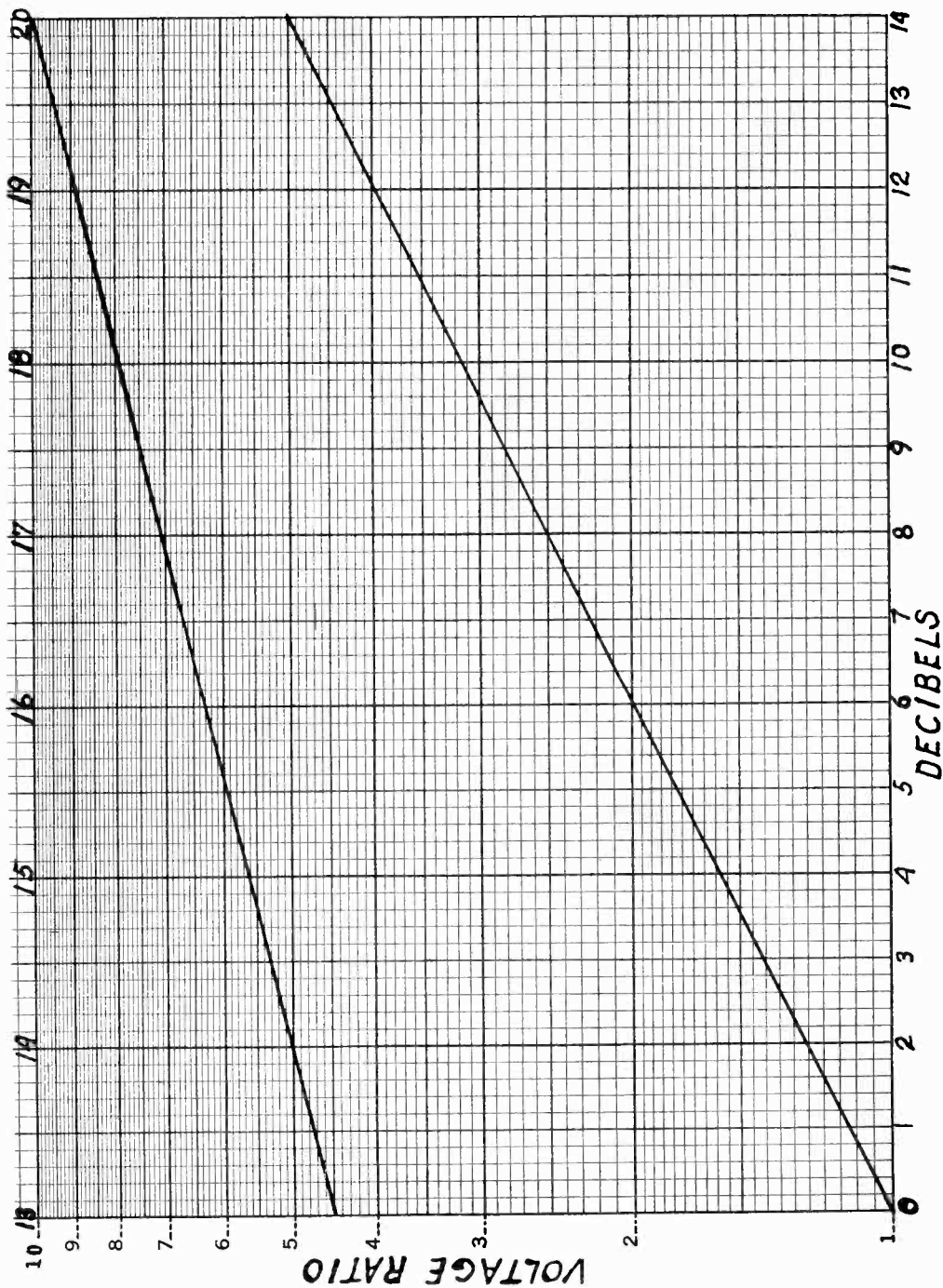

This shows the relation between voltage or current ratios from 1 to 10 and power attenuation in decibels. The curve is broken up into two sections in order to get a more favorable decibel scale. Note that the attenuation is of power.

55 Watts from 6L6's

Output Compensator Improves Quality

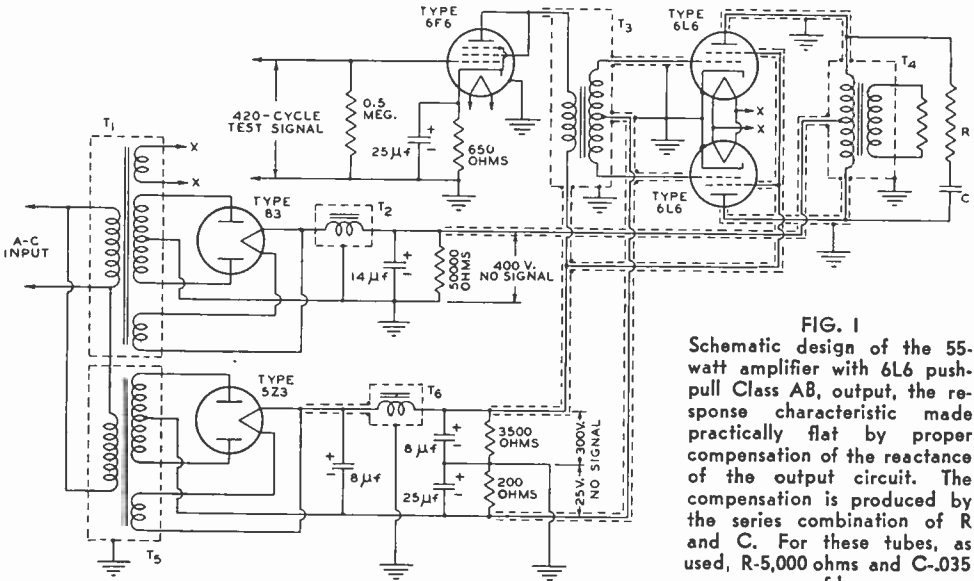

FIG. 1
Schematic design of the 55-watt amplifier with 6L6 push-pull Class AB₂ output, the response characteristic made practically flat by proper compensation of the reactance of the output circuit. The compensation is produced by the series combination of R and C. For these tubes, as used, R-5,000 ohms and C-.035 mfd.

TWO type 6L6 tubes can furnish 60 watts at 2 per cent distortion when they are operated in an ideal Class AB₂ amplifier. However, when they are used in a practical amplifier designed for the 60-watt operating condition, the low distortion obtainable from the ideal amplifier cannot be realized. In the amplifier described, 55 watts at approximately 7.5 per cent distortion can be obtained. This am-

plifier can furnish more than 60 watts, but the recommended maximum screen dissipation is exceeded at these outputs. The data shown in the attached curves were obtained from measurements made with the equipment to be described.

Two types of distortion should be distinguished: (1) plate-circuit distortion, due to the characteristics of the plate circuit, and (2) grid-circuit distortion, due to the effects of grid current flowing through an external impedance in the grid circuit. Plate-circuit distortion can be minimized by selecting the proper plate load; grid-circuit distortion can be minimized by reducing the external grid-circuit impedance to a minimum or by confining the grid-voltage swing to the negative portion of the operating range. However, it is sometimes necessary to operate in the grid-current region in order to obtain high power output.

GRID CURRENT DISTORTS WAVE

When tubes are operated as a Class AB₂ amplifier it is necessary to furnish the grids of these tubes with sufficient power to supply the losses in the grid circuit. This power is usually furnished by a driver tube through a suitably-designed input transformer. The equivalent impedance in the external grid circuit of the output tubes consists of the reflected resistance of the driver tube, the reflected resistance and leakage reactance of the input transformer's

Coil Identification For 55-Watt Amplifier

The transformers and choke used in the amplifier, Fig. 1, have commercial specifications, identified as follows:

Power Transformer (T₁ in Fig. 1): Specifications JTC-2.

Filter Choke (T₂ in Fig. 1): Specifications S-137.

Input Transformer (T₃ in Fig. 1): Specifications S-154.

Output Transformer (T₄ in Fig. 1): Specifications JTC-3.

The specifications are also the design numbers of RCA Manufacturing Co., Dept. RW, Harrison, N. J.

primary, the resistance and leakage reactance of the input transformer's secondary, and the grid-bias resistance. The wave form of the input signal is distorted when grid current flows through the series connection of these impedances; this distortion consists of third and higher-order odd harmonics and sounds disagreeable to a listener, although the presence of these harmonics may not be apparent from an inspection of a total harmonic distortion characteristic.

To reduce the external grid-circuit impedance of the output stage a low-resistance driver tube and a well-designed input transformer should be used. The driver tube should also be capable of supplying the power required by the grids of the output tubes and the input trans-

formation variations with power output are reduced; however, distortion may rise appreciably. With some intermediate value of bias regulation, which depends on the value of plate and screen regulation, optimum conditions obtain. Bias regulation should be improved as plate and screen regulation are improved. It is best to determine the proper value of bias regulation by test.

Fig. 1 is the circuit of a power-supply unit and amplifier designed to furnish 55 watts to the primary of the output transformer. The driver stage consists of a 6F6, connected as a triode, and a suitable input transformer. The output stage consists of two 6L6's connected in push-pull. The no-signal plate voltage is 400 volts, the no-signal screen voltage is 300 volts,

FIG. 2

Two curves, showing the frequency characteristic of the amplifier, "before and after". Without compensation the curve is decidedly steep. With compensation it is practically flat from 300 to 5,000 cycles, the rise between 200 and 300 cycles being small also and about the same as that between 5,000 and 10,000 cycles.

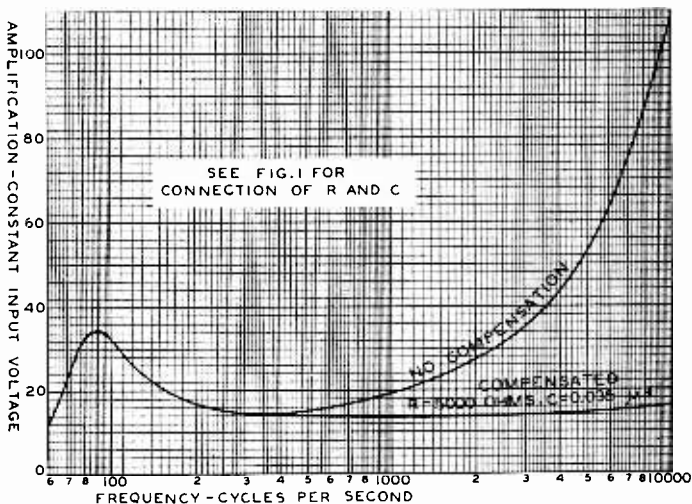

former with small distortion. The input transformer should furnish a signal of proper amplitude to the output tubes, reflect the least impedance into the grid circuit, and reflect the proper plate load to the driver tube.

The effect of power-supply regulation in a Class AB amplifier is to cause plate and screen voltage to decrease and control-grid bias to increase as power output increases. In a practical amplifier, therefore, optimum conditions at full output may be different from the optimum conditions that obtain when electrode voltages do not vary with power output. The no-signal bias should be such that it increases to an optimum value at full output.

POWER AMPLIFIER CIRCUIT

There is an optimum value of bias regulation for given values of plate and screen regulation. When the internal resistance of a bias-supply source is zero, reductions in plate and screen voltage with power output are comparatively large. The effect of reducing plate and screen voltage is to decrease power output; some change in load resistance may be necessary to minimize distortion. When the internal resistance of the bias-supply source is high, electrode-

and the no-signal bias is -25 volts.

Plate voltage is obtained from a power-supply unit which uses an 83 as rectifier; screen and bias voltage are obtained from a second power-supply unit, which uses a 5Z3 as rectifier. Thus, the effects of large variations in plate current are reduced. An advantage of this arrangement is that over-heating of the 6L6's cannot occur when the bias resistor open-circuits or when the 5Z3 is removed from its socket. A disadvantage is that the screen current can rise to abnormally high values when the 83 is removed from its socket. Some means should be employed to prevent the flow of high screen currents when the 6L6 plate voltage is removed.

BETTER REGULATION

The input element to the plate-supply filter is a choke coil. The regulation which can be obtained from a choke-input filter is considerably better than the regulation which can be obtained from a condenser-input filter. A choke-input filter requires more input voltage and less current than a condenser-input filter; therefore, the size of the power transformer is nearly the same for both types of filters. A condenser-

(Continued on next page)

(Continued from preceding page)

input filter is used in the screen-voltage supply unit, because screen current fluctuations are small.

Complete specifications for the plate-supply power transformer, input filter choke, input transformer, and output transformer are in existence. The design of the screen-voltage supply unit is conventional.

The wires in the vicinity of the output-tube sockets were carefully placed and shielded, as indicated in Fig. 1. A cathode-ray oscillograph was connected across the primary of the output transformer while listening tests were conducted and measurements were made. No trace of oscillation could be detected by this means. In the event that oscillation does occur, the placement of the output-stage wiring should be changed and the shielding should be made more thorough.

It is desirable to connect a resistance-capacitance filter across the primary of the output transformer. This filter serves to flatten the frequency characteristic of the amplifier and to prevent the generation of high transient voltages in the plate circuit. Under certain conditions, these transient voltages may be high enough to cause an arc between the plate lead and its eyelet inside the tube.

DAMPING A TUNED CIRCUIT

High transient voltages may be generated in the plate circuit of a tube when its load contains reactance. In a typical amplifier, the leakage reactance of the output transformer and the inductive component of the speaker impedance constitute part of the load impedance. The output capacitance of the tube, the distributed capacitance of the output transformer, and stray circuit capacitances tune the inductive component of the load impedance to a certain frequency.

Unless this tuned circuit is highly damped, transient voltages of sufficient magnitude to damage the tube may be generated. The addition of capacitance across the primary of the output transformer serves to lower the resonant frequency of this tuned circuit. When the resonant frequency falls within the frequency range of the speaker, these transient voltages are audible and are superimposed on the normal output. The presence of these transients cannot be detected by an inspection of a frequency characteristic made under steady-state conditions.

At frequencies lower than the resonant frequency of the equivalent output circuit and higher than the resonant frequency of the speaker, the load presented to the output tubes acts like an inductance and resistance in series. This inductance is composed of the speaker inductance and the leakage inductance of the output transformer, referred to the primary of the output transformer. Thus, transient voltages are generated across the equivalent inductance in the plate circuit at medium audio frequencies.

INTRODUCING COMPENSATION

Correct compensation for the effects of an inductive load is obtained when the impedance of the load is made resistive by connecting a suitable resistance-capacitance network across the primary of the output transformer, as shown in Fig. 1. R should be made equal to $1.3 R_L$, where R_L is the recommended plate-to-plate load (3800 ohms); C should be adjusted until the frequency characteristic is flat. When the load is compensated for the effects of inductance in this manner, the impedance of the load is nearly independent of frequency above 400 cycles. Transients are eliminated and the high-impedance tubes and load act like low-impedance triodes at these frequencies. Frequency characteristics of the amplifier described in this Note with correct compensation and with no compensation are shown in Fig. 2. A loudspeaker was connected to the amplifier during these tests.

An harmonic analysis was made of the output. Low-order harmonics are present at comparatively low outputs. A rapid rise of the seventh harmonic at the grid-current point was due to the effects of grid current and grid-circuit impedance. An output of 55 watts at approximately 7.5 per cent distortion was obtained at full output. Approximately 26 watts at 2.7 per cent distortion was obtained at the grid-current point.

SHOWS THE ATTAINABLE

Two 6L6's when operated in the amplifier described can furnish 55 watts to the primary of the output transformer. The distortion, which is mainly third harmonic, is approximately 7.5 per cent. Other amplifier and power-unit designs may be used to obtain comparable results. The amplifier described is suggested in order to show what can be obtained with practical equipment.

Copyright 1937 by RCA Manufacturing Co., Inc.

10 Kc Channels Asked for 1,510-1,600 Kc Range

Washington.

Extension of the standard broadcast band upward, to allow channels from 1,510 to 1,600 kc, inclusive, has been proposed to the Federal Communications Commission by Radio Manufacturers Association, Inc. From 40 to 500 more stations could be accommodated, de-

pending on the allocation plan, and assuming 10 kc channel separation.

The selectivity of modern receivers renders clear reception practical even with separation as small as 10 kc on the range included in the proposed extension of the band, because superheterodynes prevail.

Right or Wrong?

PROPOSITIONS

- 1 In a resistance-coupled audio amplifier, the higher the plate load resistor, the flatter the frequency response or characteristic, because then a fixed resistor is a larger part of the total resistance, and the reactive effect of the tube resistance is overcome.
- 2 The 913 cathode-ray tube may have the same heater winding as the amplifier and other tubes in an oscilloscope, because the 913 is built to have a large d.c. potential difference between cathode and heater.
- 3 The phases are 180 degrees apart in the grid and plate circuits of a vacuum tube, except that when very high radio frequencies are generated, the phase angle closes, and the two circuits may be of approximately the same phase, requiring for oscillation that the tickler be wound and connected in exactly the same direction as is the grid coil to which the plate winding is coupled.
- 4 Television signals depend on the band width being large in a receiver, so that the wide variation of amplitude, introduced by the modulation may be passed without much attenuation, thus insuring clearer and truer pictures, so that a slight difference between the generated i. f. in a superheterodyne receiver and the frequency to which the i. f. channel of the set is tuned, improves the capabilities of handling modulation of great width.
- 5 The response characteristic of an i. f. or r. f. amplifier can be obtained only by visual examination on a cathode-ray oscilloscope, and therefore flat-top peaking without a 'scope is impractical.
- 6 Frequencies that are integral multiples of a fundamental frequency, and arising from the fundamental, are called harmonics, the fundamental being called the first harmonic. The intensity of harmonics decreases as the harmonic order increases, rapidly at first, slowly finally, until the intensity difference between consecutive or other high order harmonics becomes negligible.
- 7 An ohmmeter calibrated for one scale is applicable to higher orders by a factor equal to the one by which the external voltage and the limiting resistor are multiplied.

ANSWERS

- 1 Wrong. Due to the output capacity of the tube, and associated capacity in circuit that shunts the output, the effect of this capacity is increased the higher the plate load resistor, and the high-frequency response is greatly reduced as the load resistance is increased considerably beyond normal value. The relative resistance of the load to the tube itself has no direct bearing on the topic in the sense indicated.
- 2 Wrong. The heater winding is positive in respect to B minus by the drop in the biasing resistor, usually a potentiometer in the bleeder network, and is served by an individual winding. The 913 has heater tied to cathode inside the tube, hence is built to have zero difference of any kind of potential between heater and cathode.
- 3 Right. The grid phase shift under such circumstances was only recently discovered.
- 4 Right. The wider bandwidth capabilities of the slightly mistuned intermediate amplifier is due to a response characteristic much wider on one side than on the other, hence if a single sideband is favored, the accommodation to this sideband is much wider than normally.
- 5 Wrong. It is practical to use a signal generator and tube voltmeter and obtain the response characteristic.
- 6 Right. By common use the fundamental is called the first harmonic.
- 7 Right. The low-range scale may be multiplied by 10 if the limiting resistance and the external voltage are likewise multiplied, or by 100, or any other factor applicable to all three.

A Baby Volume Expander

Simple Circuit for Phono and Other Uses

By George V. Du Buc

Douglas Radio

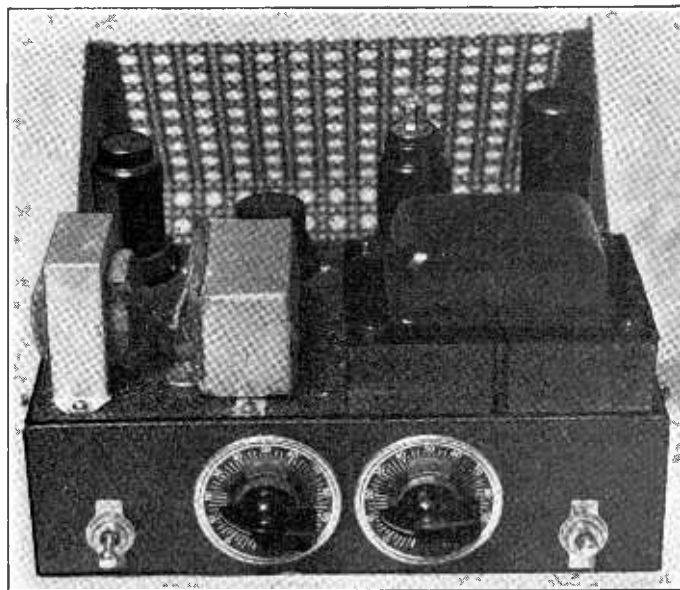

View of the housing of the volume expander, with the controls. The device has four tubes. The expansion purpose is to establish reproduction exactly as the original sounded in the phonograph recording or radio studio, thus compensating for compression practised in those places.

DURING the past few years many have bought phono-motors and pick-ups for the playing of records through radio sets. Of those who bought their phonograph units for the reproduction of the finer and more artistic recordings (as distinctly apart from those who merely need a lot of noise by which to dance) perhaps some may have been rather disappointed. This will be very true of those who have attached their phonograph unit to small sets, the result being lack of depth and tonal quality.

The Volume Expander is actually a small amplifier serving as neutralizer between the louder and softer tones. It is of course understood that in making recordings of symphonic orchestras for phonographic purposes, loud passages and certain instruments have to be suppressed somewhat while the quieter passages are perhaps slightly amplified, the whole forming a balance for recording purposes, but not the same balance which would be appreciated were the rendition heard by personal attendance.

COMPENSATES FOR RECORDING

While it may be said that recording today is satisfactory, it is by no means perfect; hence mechanical aids such as this volume expander serve a really definite purpose. Conversely to the operation of radio and recording studios the volume expander broadens the louder notes and

subdues the lower notes, clarifying them and restoring that balance of high and low tones, blending all into richness, roundness and full tonal fidelity inasmuch as the record itself is perfect.

Herewith is a diagram of such a volume expander, simple, yet so effective as to have won praise for the results obtained.

The expander consists of four tubes: one 6L7, one 6C5, one 6H6 and one 80. It is self-powered and may be attached to any radio set, not only for phonograph recordings, although primarily designed for that purpose, but for any regular radio program, by means of one wire attached to ground and one wire to the grid of the power tube, or to the driver tube if push-pull amplification is used. There are two switches, one to turn the device on and one to cut the expander in and out of the circuit, thereby enabling a comparison to be made.

HOW THE CIRCUIT WORKS

There are two controls, one for volume and one for expansive control, giving any degree of expansion best suited to one's fancy. Anyone assembling this kit will, I know, be more than pleased.

Gain of the 6L7 as an audio amplifier is changed by varying the bias on the No. 3 grid. When the bias of the No. 3 grid is made less

New Harmonic Analysis Two Methods of Frequency Measurement

By H. J. Bernard

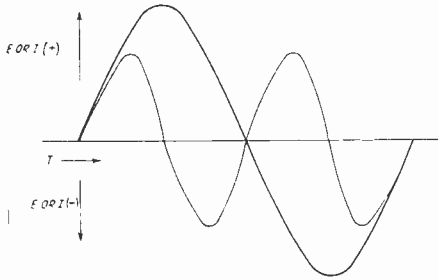

Harmonics are whole-number multiples of a fundamental frequency. Diagram shows fundamental and second harmonic content. There are twice as many pulses of the harmonic as of the fundamental.

ONLY in the past few years has any serious consideration been given to the mathematical relationship of harmonics, and the extensive use that harmonics provide in frequency measurement. Practically all of the technical press is barren of any details of the harmonic relationships, except the simplest one, that a fundamental contains frequencies that are integral multiples of itself. The Federal Communications Commission, in its frequency-checking of broadcast stations, uses practically the only application that has been given any considerable attention, whereby standard fixed frequencies are intermodulated, a beat registered with the station under check, and the audio value of the difference noted. Harmonics up to the 150th have been used in this work. The technique is set forth in a mimeographed pamphlet the National Bureau of Standards supplies in connection with its standard frequency transmissions.

One of the earliest examples of ingenuity applied to harmonic practice was set forth six or more years ago in "Wireless World," a British publication. The author showed that the harmonic orders could be obtained from inspection of the capacity ratios of the generator. Therefore the harmonics could be identified and the generator frequency could be checked accurately against stations, or stations checked against a standard generator.

CLOSE ACCURACY

That method is based on the same principle as is invoked in comparison of the frequency ratios of the generator, since the capacity ratio is simply the square of the frequency ratio. But a calibrated capacity condenser is not normally at hand, whereas a frequency-calibrated gener-

ator may be splendidly checked against stations of high reliability, especially in the United States, where the percentage accuracy of frequency is required to be very high, lest the station's license be revoked. The deviation must not exceed 50 cycles. For the lowest frequency of 540 kc this is about .01 per cent., whereas for 1,600 kc it is about .003 per cent.

If the first and second harmonic are considered, the higher frequency is twice that of the lower, the frequency ratio is 2, and the capacity ratio is 2^2 or 4. Hence if capacity is used for comparison, if the ratio is 4 the harmonics are first (fundamental) and second.

Suppose the second and third harmonics are in mind. Now the higher frequency is 1.5 times the lower, obtained by dividing 2 into 3, and the capacity ratio is 1.5^2 , or 2.25. Only consecutive harmonics are considered, to avoid confusion.

The point is that, if one has the calibrated condenser, and knows the capacity values distributed in the circuit, and takes them as a single total, he may obtain the ratio directly and ascertain the harmonic orders.

TABULATED RATIOS

High orders can not be handled so very accurately, because of the ultimately fine difference in ratios, as may be realized from the following:

TABLE I

Harmonic Orders	Frequency Ratio	Capacity Ratio
1st and 2d.....	2	4
2d and 3d.....	1.5	2.25
3d and 4th.....	1.333	1.77
4th and 5th.....	1.25	1.5
5th and 6th.....	1.2	1.44
6th and 7th.....	1.167	1.361
7th and 8th.....	1.143	1.31
8th and 9th.....	1.125	1.265
9th and 10th.....	1.111	1.234
10th and 11th.....	1.1	1.21
11th and 12th.....	1.091	1.19

Next came the formula for determining an unknown frequency higher than two related generated frequencies. The unknown, for consecutive harmonics or responses, receiver unchanged, equals the product of two low frequencies divided by their difference. The unknown frequency is therefore the least common numerator.

For the two low frequencies, if the difference between them is divided into one of them, the result is the harmonic order of the *other*. Hence this one formula introduces a double check, as the same answer is provided by multiplying the

lower frequency by the higher harmonic order, and the higher frequency by the lower harmonic order.

MORE NUMEROUS RESPONSES

Again for simplicity consecutive responses are used, but if more numerous responses are preferred, so that a greater part of generator dial will be traversed, the product of the two low frequencies is multiplied by $n-1$, where n is the total number of responses. In other words, the total number of differences is used.

Thus for terminal frequencies of 120 and 80 kc, total responses being five, the product is 9600, the difference is 40, but the division is not of 9600/40 but of $(9600 \times 4) \div 40$ and the unknown is 960 kc.

The author contributed the addition method, where the addition of the known consecutive low frequencies, divided by the difference, yields a number that is the sum of the harmonic orders. Thus, if the low frequencies are 150 and 200 kc, add them, getting 350 kc, and divide by the difference, 50, getting 7, so the harmonic orders are 4 and 3. These are easily determined by inspection, or may be factored as $(n + 1)/2$ and $(n-1)/2$, where n is the dividend. The sum divided by the difference is always a whole number, because the harmonic orders, hence their sum, always are whole numbers. The unknown in this example is $3 \times 200 = 4 \times 150 = 600$ kc. This expression brings out the fact that the same product results, and why the lower frequency is multiplied by the higher harmonic order, and the higher frequency by the lower harmonic order. Simple as this is, even mathematicians sometimes challenge it in conversation, as if "higher and higher" and "lower and lower" should go together!

NEW METHOD PRESENTED

A good deal of the new facts on harmonic analysis has appeared first in these columns, and no doubt in time a number of other aspects will be revealed, as the harmonic relationship is, as its name implies, harmonious in Nature, and that fact must suggest that there are many ramifications as yet unbroached.

If the two low frequencies are again noted, and if they are divided by consecutive whole numbers from 2 up, the dividends put on one line for one low frequency, and on the next line for the other frequency, the dividends being tabulated so as to apply to pairs of low frequencies, then the harmonic orders are ascertainable by inspection. They are the first common numbers to show up. Also, the method applies to other than consecutive harmonic orders.

Taking the same example as before, of 150 and 200 kc, and applying the tabulation method, we have:

1	2	3	4	5	6	7	8
150	75	50	37.5	30	25	21.43	18.75
200	100	66.6	50	40	33.33	28.57	25.

The first common dividend is 50, and has been put in blackface type to accentuate the fact. There will be other common dividends at 50/2, 50/3 etc. The harmonic orders are the

dividends, in this example 3 and 4, and, as previously, the lower of the low frequencies is multiplied by the higher of the harmonic orders, and the higher of the low frequencies by the lower of the harmonic orders, to obtain the result, here 600 kc. Only one multiplication need be performed. The other may well be included, however, as a check.

NON-CONSECUTIVE HARMONICS

The method works out very simply and is easily remembered from the tabulation. However, the rhetorical formula sounds very forbidding: Divide the fundamental frequencies, the harmonics of which are influencing the detector, by 1, 2, 3, etc., and the first common dividend to show up equals the difference between the two fundamental frequencies, also the divisors producing the common dividends equal the non-respective harmonic orders, and F_x equals the product of divisor of one known fundamental and the other fundamental itself, or the product of both divisors and the greatest common denominator (identical with the difference).

Let us set forth two more examples:

1	2	3	4	5	6
100	50	33.33	25	20	16.66
120	60	40	30	24	20

The difference is 20, obtained by inspection instead of by subtraction, and the two multipliers, or the harmonic orders, are 5 and 6 in reverse, i.e., one fundamental is multiplied by the other fundamental's harmonic order.

$F_x = 100 \times 6 = 120 \times 5 = 6 \times 5 \times 20 = 600$ kc.

Finally let us try a non-consecutive harmonic analysis.

1	2	3	4	5	6	7	8	9
19.111	9.555	6.37	4.78					
43	26.5	14.44	10.7	8.6	7.16	6.14	5.25	4.73

Here $F_x = 19.111 \times 9 = 43 \times 4 = 9 \times 4 \times 4.78 = 172$ kc.

The foregoing inspection method was devised by the author.

COMMON MULTIPLICATION

In this example, as in the previous one where the harmonic orders showed up, the unknown also equals the product of the harmonic orders and the difference frequency. The difference is 50, for the least common denominator of the two low frequencies is the difference between them, in harmonic technique, and $3 \times 4 \times 50 = 600$.

We know two inter-related low frequencies and from them can ascertain an unknown frequency higher than either. The methods so far discussed concern just that procedure. Suppose the low frequencies are 125 and 138.888 kc. You can find the unknown frequency from any of the methods outlined. It is 1250 kc. Now, suppose a second station provides a zero beat at 125 kc, also. For 1250 kc the beat was due to the tenth harmonic of the generator frequency. Obviously the second station zero beats with some other harmonic of the same generator frequency. If we knew that harmonic we would know the frequency of the second station, by multiplying the generator frequency by the harmonic order. Without reading any other fre-

(Continued on page 53)

List of Submultiples of Station Frequencies for Harmonic Reference

H	WMCA	WEAF	WOR	WJZ.	WNYC	WABC	WAAAT	WHN	WLWL	WINS	WNEW	WHOM	WMBQ
1	570	660	710	760	810	860	940	1010	1100	1180	1250	1450	1500
2	285	330	355	380	405	430	470	505	550	590	625	725	750
3	190	220	236.666	255	270	286.666	313.333	336.667	366.667	393.333	416.666	483.333	500
4	142.500	165	177.500	190	202.500	215	235	252.5	275	295	312.500	362.500	375
5	114	132	142	152	162	172	188	202	220	236	250	290	300
6	95	110	118.333	126.666	135	143.333	156.666	168.333	183.333	196.666	208.333	241.666	250
7	81.428	94.286	101.428	108.571	115.714	122.857	134.286	144.286	157.143	168.555	178.555	207.143	214.286
8	71.250	82.500	88.750	95	101.250	107.500	117.500	126.250	137.500	147.500	156.250	181.25	187.500
9	63.333	73.333	78.888	84.444	90	95.555	104.444	112.222	122.222	131.111	138.888	161.111	166.667
10	57	66	74	76	81	86	94	101	110	118	125	145	150
11	51.818	60	64.545	69.091	73.636	78.182	85.454	91.818	100	107.273	113.636	131.888	136.364
12	47.500	55	59.166	63.333	67.500	71.666	78.333	84.167	91.666	98.333	104.166	120.833	125
13	43.846	50.761	54.615	58.462	62.308	66.154	72.308	77.692	84.615	90.769	96.154	111.539	115.385
14	40.714	47.143	50.714	54.285	57.857	61.428	67.143	72.143	78.571	74.277	89.277	103.571	107.143
15	38	44	47.333	50.666	54	57.333	62.666	67.333	73.333	78.666	83.333	96.666	100
16	35.625	41.250	44.375	47.500	50.625	53.750	58.750	63.125	68.750	73.750	78.125	90.625	93.750
17	33.529	38.823	41.765	44.706	47.647	50.588	55.294	59.412	64.706	69.412	73.529	85.294	88.235
18	31.666	36.666	39.444	42.222	45	47.777	52.222	56.111	61.111	65.555	69.444	80.555	83.333
19	30	34.737	37.368	40	42.631	45.263	49.474	53.158	57.894	62.105	65.789	76.315	78.942
20	28.5	33	29.588	38	40.5	43	47	50.500	55	59	62.500	72.500	75

and the result is the percentage accuracy of the generator. It is assumed that the generator is not grossly inaccurate, so that confusion could result due to wrong fundamental compared to the listed frequency.

The vertical column H at left therefore, when the submultiples under the station frequencies are considered, reveals the harmonic orders of the low frequencies. There is a great variety of close mathematical unison in harmonic technique, and fortunately definite frequencies can be spotted and all confusion avoided.

One method is to use cross harmonics. If a single frequency of the generator will cause one of its harmonics to zero beat with one station and a consecutive harmonic to beat with another station, generator unchanged received alone returned, then the generator frequency can not be mistaken, provided that in tuning the receiver no response is heard in between the two settings.

The beat is zero in both instances. Cross harmonics are in bold type.

TABLE II herewith is based on the division of the frequencies of thirteen broadcasting stations in the metropolitan district by twenty-one consecutive whole numbers, from 1 to 20 inclusive. The station frequencies are given on the top line. The subdivisions of these frequencies appear in the vertical columns under the station frequencies. At left, the vertical column of numbers, 1 to 20, gives the divisors. So any sub-frequency on any horizontal line, when multiplied by the number on the same line at extreme left, equals the frequency at the top of the column in which the submultiple appears. Therefore if the submultiples are fundamental frequencies, for instance as found in a signal generator, then the generator may be checked as to accuracy, by reading its dial-inscribed frequency, and comparing it with the true frequency, as found in the list of submultiples.

If there is a difference, found by subtracting the lower from the higher value, divide this difference by the true frequency, as found in the table,

(Continued from preceding page)
 frequency than 125 kc, find out the frequency of the second station.

SECOND NEW METHOD

The procedure is as follows: zero beat the generator with the station of known frequency. Tune the set to the unknown frequency and zero beat as check, generator not disturbed. Then return to the first station and turn the generator to its next higher frequency to produce a response at the known station frequency. Retune the set to the unknown. Keep doing this, meanwhile counting responses against the known station, until again a common generator frequency beats with both known and unknown. Now the generator frequency also is twice what it was at first. Tune in the unknown station on the set, count the responses while returning to the original generator setting, and you have the total responses for both known and unknown, over a 2-1 frequency ratio of the generator. The unknown is the ratio of these numbers to the known station frequency. In symbols the formula is:

$$F_x = f_1 \frac{n-1}{n-1}$$

where F_x is the unknown frequency, f_1 is the known station frequency, n is the total number of responses for f_1 , and m is the total number of responses for F_x .

Whether the unknown is higher or lower than the unknown is taken care of automatically in the formula.

It will be observed the method includes a procedure for finding the second harmonic of a known generator frequency, or a frequency half that of a selected generator frequency.

SIMPLIFIED APPLICATION

Since in practice if the generator frequency is known for one setting it is known for the multiple or submultiple, because the dial is calibrated and checked, we can simplify the application by beating with the known station, using a known low frequency, and counting the responses for the known and unknown stations. Thus the ratio is rapidly produced and the formula remains unchanged.

Applying the easier technique beat 125 kc with 1250 kc, count the responses as generator is turned to twice or half the first frequency, and say the number is six. Count the responses for the same generator span when the unknown station is tuned in. Say the number is seven. Since seven is higher than six, the unknown is higher than the known. Subtract one from each response total, to express the number of differences, that is, we are guided by $n-1$. So the numbers are 6 and 5 finally and the unknown is $6/5 \times 1250 = 1500$ kc.

DIFFERENCE DIRECTLY

This boils down to a still simpler expression, where the responses are counted as before, differences alone considered ($n-1$), and the unknown equals the known station frequency plus or minus the product of the plain difference in

response numbers and the low common frequency of the generator. So

$$F_x = f_1 \pm [(o-p) f_0]$$

where F_x is the unknown frequency, f_1 is the known station frequency, o is the total number of responses for f_1 and p the total number of responses for F_x and f_0 the common oscillator fundamental.

No attention need be paid to $n-1$, where n is the total responses, as a difference is established directly and would not be changed by introducing $n-1$. If o is larger than p the unknown is lower than the unknown and the sign is negative. If p is larger than o the unknown is higher than the known and the sign is positive.

INTERPOLATIVE METHOD

A related problem now may be examined. Suppose a generator is to be calibrated, starting at 100 kc, and there is no station within ready reach that is on a multiple of 100 kc. Select some such frequency at random, say 1100 kc. The problem is to find the receiver setting for this. If 550 kc is receivable on a set of course a generator at 550 kc would produce 1100 kc second harmonic, and the set tuned to the second response position, generator not changed. But assume 550 kc out of reach. Find the submultiples of 1100 kc, as in table II, and the submultiples of receivable lower station frequencies. Pick out cross harmonics between the two. Say the lowest frequency station is 660 kc, submultiples including 220 and 110 kc. Start at 110 kc for 660 kc and count the responses, total for all being four (110, 132, 165 and 220 to encompass the 2×1 ratio). For 1100 kc the number of responses, read from the list, would be six for generator tuned from 110 to 220 kc. The difference in responses is $6-4=2$. Therefore the receiver setting is the one producing the six responses, all counted, and the frequency is 1100 kc because to the known 660 is added in effect the difference in responses (2) multiplied by the highest generator frequency used ($2 \times 110 = 220$ kc). So $660 + (2 \times 220) = 660 + 440 = 1100$ kc. Knowing the 110 kc position of generator, tune generator to include a little more capacity until the response results at 1100 kc receiver frequency, and the generator is at 100 kc, since there is no response in between. See Table II, under WLWL, 1100 kc, showing tenth harmonic of 110 kc and eleventh harmonic of 100 kc equal 1100 kc.

AUDIO DEVELOPMENT

In the foregoing text frequent mention was made of zero beat. This condition exists when two oscillators are tuned to exactly the same frequency. There is no difference between the frequencies, they are identical, there is zero beat, as the word beat represents difference. Whenever there is a finite difference there is a finite frequency, which, if low enough, say, 50 to 10,000 cycles, may be heard, and if too high cannot be heard, and besides does not figure in common practice.

It is therefore obvious that audio values can be developed. It is not so obvious that zero beat as a practical attainment is very difficult if not impossible. The coupling between the two os-

(Continued on page 61)

Precision Marks Super Pro

Coils, Switch, Condenser Analyzed and Tuning

By Donald Lewis

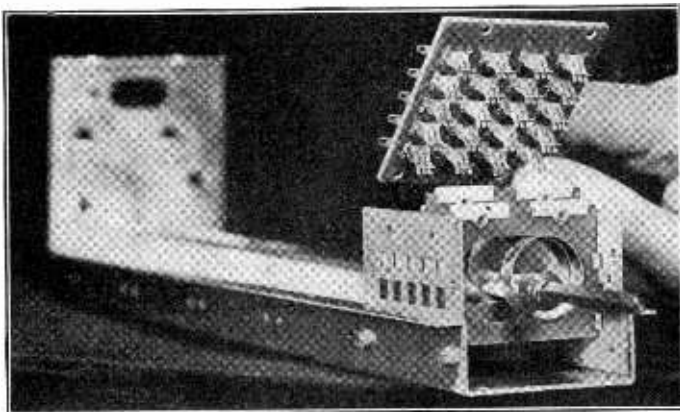

Cams raise and lower silver-plated knives in the coil switch to engage the two-sided lugs in the Hammarlund Super-Pro. The brass eccentric cam is just behind the squared shaft. The square object with elliptical cutout, just behind the cam, has two silver-plated knife edges eyeleted to it.

SINCE the publication of the articles on the new Hammarlund Super Pro in the January and February issues of RADIO WORLD, I have received so many letters requesting further data on design and constructional phases that I am devoting most of this discussion to answering these inquiries and I am including, too, other details that I believe will prove interesting.

Many asked me further to describe the cam knife switch that is used in the Super Pro, particularly requesting details on its actual operation. Each section of this switch constitutes a two-pole five-position unit. The silver-plated knives, mounted on Bakelite panels sliding in guides and raised and lowered by cams on the switch shaft, eliminate the necessity for pigtailed, wiping rotary contacts and even the pivot of the knife blade, the chief source of trouble in the standard knife switch.

THE SWITCH COMPONENTS

In the illustration, the various components of this switch are clearly shown; viz., the brass cam, bakelite knife with its silver-plated edge, the sturdy switch housing and the silver-plated contacts which, as will be noted, are split to provide triple contact.

It will be noted, too, that the rotating rod is a square design, affording a most positive grip for the knob and preventing slipping of any kind. Silver-plated short-circuiting springs automatically short the four open contacts at all times thus further eliminate losses.

The timing of the cams and arranging of the contacts is such that the circuit through one

setting of knives is not broken until contact is made with another set. This avoids sparking in the sections which handle plate current and also prevents open grid circuits when the switch is turned.

Another letter I received asked for the capacity of each section of the tuning condenser and a few mechanical details involving its construction. Each section of this condenser has a capacity of 180 mmfd. The rotor plates are the Midline type, but due to trimmer condensers result in a uniform frequency scale for the 2-to-1 range of each band. The rotor shaft is of stainless steel. The stators are mounted in Isolantite blocks.

LOW-RESISTANCE BEARINGS

The rear bearing is a single steel ball between a cupped adjusting screw and a cupped depression located in the end of a rotor shaft. The front bearing is a long self-aligning brass bushing mounted in a circular spring bronze plate to take the thrust of the single ball bearing. These very special bearings afford low-resistance contact to the rotor shaft, minimizing interstage coupling.

Another inquiry concerned the input coils. In each band, the input circuit consists of two coils: an antenna or primary coil and a grid or secondary coil.

These two coils are effectively shielded from each other electrostatically by a Faraday screen placed between them. Thus the transferred energy from the antenna to the grid is limited to pure electro-magnetic coupling. This particular coil design permits connection to a bal-

The i.f. coil feeding the second detector has been disassembled to show the neat arrangement, the inclusion of filter resistors and the use of shielded wire (lower right) for outleads. The sheath is grounded and stability at high gain is achieved.

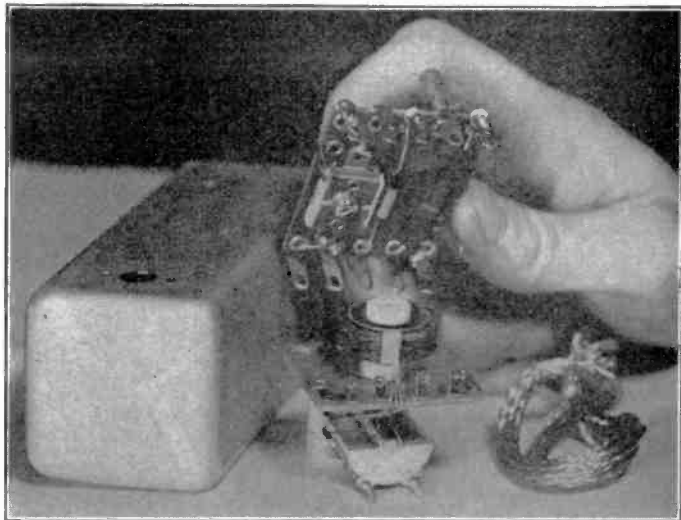

anced transmission line having an impedance of 115 ohms.

In addition to this coil are the tuning coils. In the illustration such a coil is shown and the construction of this is very unusual. A copper disc on an adjusting screw turning in a friction bushing and mounted at the top of each coil form is used to adjust the inductance for low frequency alignment.

ALIGNMENT PROCESS

High-frequency alignment is accomplished by a trimmer condenser mounted beneath the Isolantite base. All the coil forms are of Bakelite, the coils for the lowest frequency range being four bank Litz windings while the others are space wound.

In another letter was a request for a detailed description of the crystal filter system. The crystal filter as used in the Super Pro provides not only extreme selectivity for c. w. but when properly adjusted affords added selectivity for voice and other modulated signals.

The crystal holder itself is an Isolantite block ground on both sides to insure an accurate and uniform air-gap above the upper surface of the crystal. It is connected in a balanced link circuit that couples the plate circuit of the first detector to the grid circuit of the first i. f. tube. This link circuit has a relatively low impedance to match the series resistance (at resonance) of the crystal.

In the other leg of the balanced link circuit a variable condenser serves to neutralize the capacitance of the crystal and its holder. The insulated shaft of this variable condenser extends through the front panel where a knob and pointer, together with an engraved scale, permit accurate adjustment to suit various operating requirements. Maximum selectivity suitable for a single sideband c. w. occurs at or very near the point of exact neutralization, which falls at about 1 on the dial. This set-

(Continued on following page)

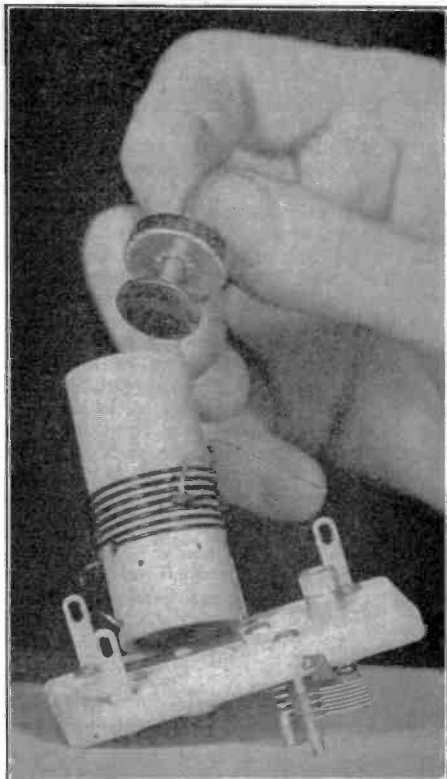

Since it is practically impossible to wind coils so that their inductance will be identical, even if the form is grooved, a method of inductance adjustment is introduced, whereby a copper disc is fitted inside the coil form in the position that establishes the required inductance.

(Continued from preceding page)
 ting remains unchanged, once found on the particular receiver in operation, unless a new

I have also been asked as to just how would I classify the Super Pro. Well, it is most certainly a precision communication receiver in

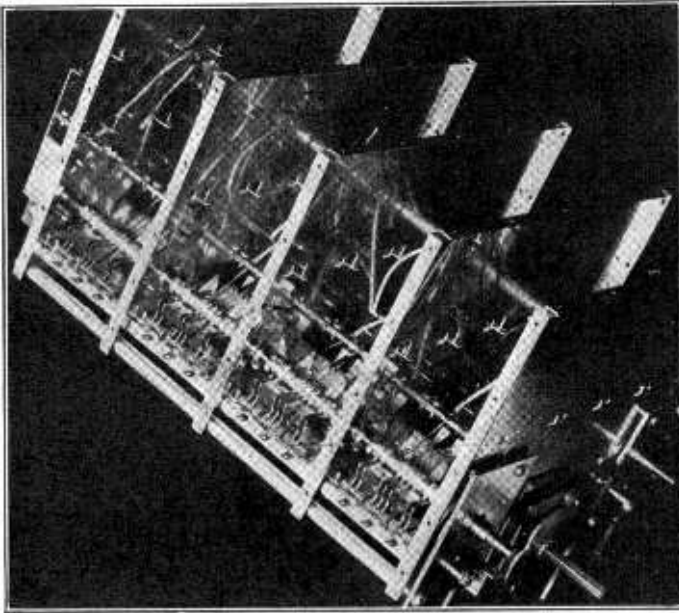

The tuning condenser has 180 mmfd. capacity per section and has trimmers across it, so the tuning is practically straight - frequency line. The four sections at left are operative on the three high-frequency bands for bandspread. Into the spaces at top go the shielded coils.

crystal is substituted. By turning the knob toward 10 the band is continuously widened until it is possible to receive voice reception which frequently under interference conditions would not be heard.

In one of the letters I was asked on what bands the band spread system operated. This system works on the three high-frequency bands from 2.5 to 20 megacycles. Below 2.5 megacycles it is automatically disconnected by the band-change switch. The calibration of the main dial is based on a bandspread dial setting of 100. Decreasing the setting of the bandspread dial decreases the resonance frequency of the receiver. Bandspread may therefore be obtained by setting the maintuning dial to the highest frequency in the desired band. When this has been done, the lower frequencies in the band may be tuned by means of the band spread dial only.

that it definitely fills every specification of the professional operator, providing effective selectivity, sensitivity, bandspread on all the high frequencies, crystal filter, beat-frequency oscillator, stand-by switch, tuning meter, a. v. c. or manual control as well as other manual controls. It is an excellent broadcast receiver, too, for in addition to these features it is possible to obtain high-fidelity reproduction. Then there is also the accurately calibrated main tuning dial for the five ranges of the receiver. There is also the very important variable band width control which permits a 3-to-16 kc variation at will and at the same time affords a tone control effect.

Thus it will be seen that the Super Pro meets the most exacting requirements with its extreme flexibility of control, exceptionally rugged construction and skillful design.

A signal generator, using Colpitts oscillator, unequal capacities.

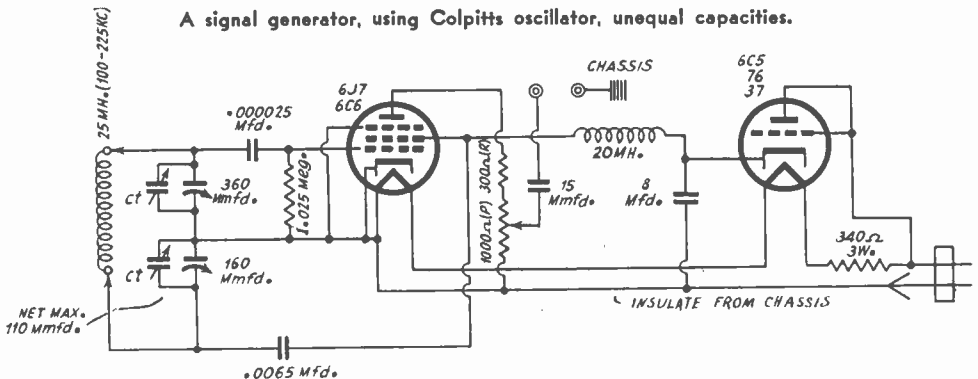

RADIO CONSTRUCTION UNIVERSITY

Answers to Questions on the Building and Servicing
of Radio and Allied Devices.

SIDEBAND CUTTING

CAN you give a brief explanation of how a selective tuner cuts out the higher audio frequency notes? It is not clear to me how the audio frequencies are related to the carrier.—N. M. A.

Analytically a radio wave modulated with a single audio tone can be broken up into three radio waves, the carrier and the upper and the lower side frequencies. The circuit is tuned to the carrier. The two side frequencies are off tune by an amount depending on the value of the audio frequency. Therefore they are partly tuned out. At the detector the audio frequency is extracted from the composite, but because of the side frequencies the modulation is not so deep as it was originally. Hence after detection the audio frequency component is not as strong as it was when it was first impressed on the carrier. This would not be so bad if it were not for the fact that the suppression is greater the higher the audio frequency. It is the relative suppression of the high frequencies that causes distortion, not the absolute amount.

* * *

CAPACITY IN OSCILLATOR

MANY times I have seen circuit diagrams of oscillators in which the tuning condenser was omitted. I have always understood that capacity as well as inductance is needed for oscillation, yet I know from experience that oscillators without capacity across the coil work. Will you explain the discrepancy?—F. W. K.

It is true that no oscillator oscillates without capacity. You must remember, however, that every coil has some distributed capacity and every vacuum tube has inter-electrode capacities. You simply cannot build an oscillator without capacity.

* * *

CALIBRATION OF CONDENSER

IS IT possible by the use of harmonics of known frequencies and of a single known capacity to calibrate a variable condenser throughout its range?—S. C. U.

Yes, it is possible. If the known capacity is small compared with the condenser to be calibrated, the work can proceed step by step. It is then only necessary to measure the capacity of the condenser at zero setting. Use can also be made of harmonics of a known frequency. Suppose m and n are any two known harmonics

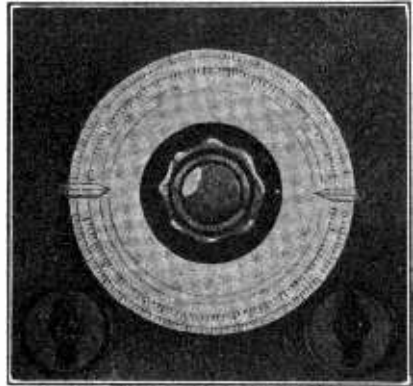

Simple cabinet layout for a one-tube device.

of the same fundamental. If C_m and C_n are two capacities at which zero beat is obtained with m and n respectively, then $m^2 C_m = n^2 C_n$. The capacities are the total capacities in the circuit, not merely the capacity supplied by the condenser. Of course, it is necessary to have one known capacity in order to find the value of any other by this means. Once a run has been started, neither the inductance nor the fundamental frequency of the oscillator should be changed.

* * *

WHAT IS A GALVANOMETER

WHAT is the difference between a galvanometer and a voltmeter, or an ammeter?—H. E. B.

A galvanometer is a current indicating instrument which has been calibrated neither for volts nor amperes. It has only a scale divided into a convenient number of equal divisions, usually one hundred. A high resistance galvanometer becomes a voltmeter when the scale is in volts. A low resistance galvanometer becomes a current meter when the scale is in current units.

* * *

HANDY LAYOUT

CAN you give me a layout for a small one-tube device, using a simple disc dial, for more than one calibrated range?—E. F. L.

The reproduction herewith will serve as guide for dial and cabinet arrangement.

TRADIOGRAMS of the MONTH

R. L. Triplett is Hailed on 35th Business Year



R. L. TRIPLETT

January marked the thirty-fifth anniversary of the entry of R. L. Triplett into the manufacturing of electrical instruments. Friends in the industry extended to him congratulations and best wishes.

Mr. Triplett is president of the Triplett Electrical Instrument Company, Bluffton, Ohio. Only last year he completed a large new air-conditioned plant with a view to taking care of his rapidly-growing requirements.

When interviewed, Mr. Triplett did not speak of the success of his company. When asked the outstanding recollection of his many years in business he replied:

"In 1932 when the bank in Bluffton closed we were hard pressed for cash to meet our payroll and maturing obligations. I personally sent a plea to our representatives to ask our jobbers for advance payment of our invoices. To encourage all the payments possible, I told them to increase their discount from two to five per cent or whatever in their opinion they thought the money was worth to them.

"Not only did we receive anticipation of invoices from practically every jobber on our books, but not one single jobber took more than the customary two per cent allowed for payment in ten days. You understand, too, that many payments came from jobbers whom I had never seen personally.

"This generous support enabled us to tide over a most critical situation. I don't feel that I have ever been able to adequately show my appreciation to the trade."

Trade Asks 455 Kc Become Standard I.F.

Washington.

Assignment of the frequency on 455 kc as an intermediate frequency standard for the industry has been requested of the Federal Communications Commission by Radio Manufacturers Association, Inc., at an engineering conference of the FCC conducted by Chief Engineer T. A. M. Craven.

A protected intermediate frequency on 455 kc is regarded as the best obtainable for radio set manufacturers. If this protected frequency is allocated by the Federal Commission assurances have been given that it will be an established standard and utilized by the industry.

Code interference at the i. f. level could be avoided by clearing the 455 kc channel.

Wholesale Radio Giving Series of Demonstrations

To all amateurs and radio enthusiasts, Wholesale Radio Service Company extended a most cordial invitation to see, hear and operate the latest-designed radio apparatus. Sound-proof display booths provide the visitor with every facility and comfort.

"A complete display of the most modern

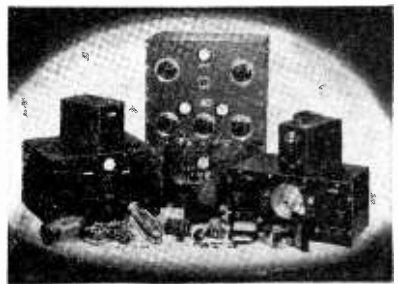

Type of equipment being demonstrated by Wholesale Radio Service Company.

'ham' receivers and a demonstration of P. A. systems for all purposes, including microphones and loud speakers, assures the radio man of a most enjoyable time," says the company.

The latest in tubes and radio components are also on exhibition. Wholesale Radio Service Company is located at 100 Sixth Avenue, New York City, with branch offices at 901 West Jackson Blvd., Chicago, and 430 West Peachtree Street, NW, Atlanta, Ga.

Exclusively Radio Store Doomed, Says Ghirardi

Alfred A. Ghirardi, well-known writer on radio topics, has just returned to New York from a nation-wide trip devoted to making a personal investigation of new developments and trends in the radio set and servicing business in different parts of the country. Traveling 3,400 miles by car and 6,200 miles by air, Mr. Ghirardi also had the opportunity to make a special study of aircraft radio equipment and reception, radio beams and other special problems connected with aviation radio. He remarked upon the absence of radios for the entertainment of air passengers in transport planes.

"In my opinion," he said, "during the next 12 months we will see a great change in the sales promotional methods and activity among all radio dealers and service men who are alive to changing conditions and new opportunities."

The second point that impressed Mr. Ghirardi was the tendency of radio dealers today to handle electrical appliances. Mr. Ghirardi believes that the day of the shop devoted exclusively to radio has gone. Thirdly, Mr. Ghirardi commented on the growth of the use of public address and intercommunication systems, particularly for retail stores. This field he is convinced will soon become one of the most lucrative for well-trained sales-minded radio technicians. Mr. Ghirardi also commented on the prevalence of parts departments in radio stores on the West Coast, indicating renewed interest and activity on the part of experimenters.

Mr. Ghirardi is author of "Radio Physics Course," "Modern Radio Servicing," "Radio Field Service Data" and is co-author of a new book recently announced, "Radio Business Promotion and Management." All four books are published by Radio & Technical Publishing Company, 45 Astor Place, Dept. 37, New York, N. Y.

Parts Shows to be Held in New York and Chicago

Radio Manufacturers Association, Inc., through its board of directors, unanimously declared a policy against set manufacturers exhibiting at public shows. The meeting was held in Chicago. The expense is unwarranted, the exhibits reduce instead of increasing sales, and the set manufacturers should not support the shows, the resolution set forth.

However, parts manufacturers are aided by shows, it was held, so two national shows will be conducted, one at the Stevens Hotel, Chicago, June 10th to 13th inclusive, the other in New York City, quarters not yet selected, October 1st to 3d, inclusive. These shows will be under joint management of RMA and Sales Managers Clubs of New York and Chicago, through a non-profit corporation. Ken Hathaway is managing director of the shows. The board of directors of the show corporation consists of A. A. Berard, Arthur Moss, S. N. Shure and Fred D. Williams. Moss and Williams represent RMA; Berard and Shure the Sales Managers Clubs.

The show corporation is founded to sponsor exhibitions of replacement parts, test and laboratory equipment for the service man; public address equipment; and amateur and short-wave equipment.

Mail Order Active

February radio mail order business started briskly and, reflecting back on manufacturers caused some of them to be behind on deliveries. Prices were not advanced, except on tubes, but it is regarded as certain that some small price increases will be necessitated some time during the next few months.

Catalogue houses are finishing a flourishing Winter season, while stores report mixed results.

Cornell - Dubilier Seals Compact Condensers

With the rapidly-increasing trend toward higher power and better fidelity in high-grade receivers, transmitters and amplifiers, there has been a correspondingly increasing demand for high-capacity, high-voltage condensers combining the excellent dependable characteristics of the bulkier types with the compactness and assembly simplicity of the can-type electrolytics. This demand has resulted in the development of the Cornell-Dubilier type TL Dykanol capacitors.

These new hermetically-sealed condensers will prove the ideal solution where reduced size, weight and cost is desired in conjunction with extremely high voltage ratings and negligible power factor. They are manufactured by the Cornell-Dubilier Corporation, South Plainfield, N. J. Full descriptive catalog No. 135A is sent free on request.

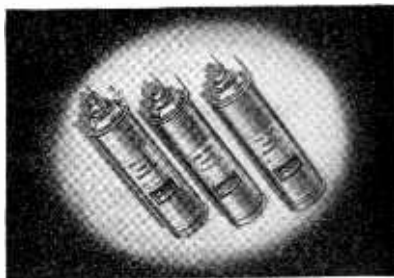

Dykanol condensers provide high capacity in small space. They are used in receivers, transmitters and amplifiers and permit efficiency with space economy.

FORUM

AS WE HOPE

I find your magazine to be one of the finest of its kind and I hope always to be able to be a subscriber.

L. A. PETRY,
1102 Pacific St., St. Paul, Minn.
* * *

HAD TO BE FOR THE BETTER

I have noticed a considerable improvement in quality of the RADIO WORLD since about a year ago,

E. M. HALL,
Box 106, Inverness, Calif.
* * *

HAPPY WARRIOR

I am happy to have subscribed for RADIO WORLD. I have been a reader of your magazine for some time and always enjoy it.

E. Y. SCHWEIZER,
Radio Mechanic, U. S. N.,
4233 Forty-third St., San Diego, Calif.
* * *

MERCI BEAUCOUP

Your magazine is very good. For instance, the explanation of A. F. C. by J. E. Anderson in the December issue was *un modèle du genre*, as we say in French.

GEORGE MOENS.
SUIRO, Box 254, Cairo, Egypt.
* * *

NEARLY BUT NOT QUITE

I think your magazine improves in nearly every issue.

B. F. LEE.
Box 293, Leaksville, N. C.
* * *

YOU'RE PRETTY GOOD, TOO

RADIO WORLD is great!

IRVING M. SEITLER.
359 South Second St., Brooklyn, N. Y.
* * *

ALL IS FORGIVEN

RADIO WORLD is positively the best book of its kind. It sure has the real dope. Pardon the slang.

HENRY VAN ZANT,
63 Tounge St., Sudbury, Ont., Can.

J. H. PAYNE SUCCEEDS CRUSE

John H. Payne, formerly export trade executive of the Westinghouse Co., is the new chief of the Electrical Division, U. S. Bureau of Foreign and Domestic Commerce, which is active in promoting electrical and radio sales. Mr. Payne succeeds Andrew W. Cruse, who was transferred to the Federal Communications Commission as assistant chief engineer of its telephone division.

What Manufacturers Say

TESTING CONDENSERS

Questions on capacity and leakage measurements were addressed to Cornell-Dubilier Corporation, South Plainfield, N. J. This corporation is a leader in the industry and has been in the same business for 26 years and makes only condensers. So we thought they ought to know the answers to some questions that vexed some of our readers. Also, we felt that these readers and others would be glad to have first-hand information from such a noteworthy source. The questions were: (1) Is it satisfactory to use low-voltage a.c. in testing the capacity of electrolytic condensers? (2) What standard of leakage should govern paper, electrolytic and mica fixed condensers? (3) Does a leakage test satisfactorily reflect the condition of the electrolytic?

ANSWERS BY ADELMAN

The answers were given by the corporation through Leon L. Adelman, sales manager of the jobbers' division. He wrote:

"With respect to the use of low voltage a.c. as a satisfactory method for determining the capacity of electrolytic condensers, we would say that this is quite all right and is standard production procedure. It is not, however, accurate for laboratory work or similar exacting applications. We recommend 10 per cent of the rated d.c. voltage for the a.c. potential to apply for capacity measurement.

"With respect to condenser leakage, if the resistance is less than 100 megohms per microfarad for a paper dielectric condenser the unit is considered poor. If the measurement reads 500 megohms per microfarad the condenser is considered good and if it reads 2,000 megohms per microfarad it is considered exceptionally good.

MICA TESTS

"On mica condensers, poor, good and excellent ratings would be 500 megohms per microfarad, 2,000 megohms per microfarad and 10,000 megohms per microfarad, respectively.

"Since the leakage of an electrolytic condenser is not a function of resistance but of completeness of film formation, it is rather difficult to give you any exact data on this particular subject. As regards reversed polarity leakage characteristics, the leakage normally is almost that of a short circuit, more so, the higher the voltage rating."

REDUCED INDUCTANCE

The inductance of coils is reduced by shielding, usually around 10 per cent.

Finding An Unknown Frequency

(Continued from page 53)

oscillators must be very loose, otherwise the low audio frequencies can not be realized, for the oscillators will lock in, hence act as one and prevent beat. No such trouble results when stations are used, as the coupling between the generator's oscillator and the station is decidedly weak. This is true although the station frequency is amplified in a receiver and the resultant note, if any, is heard in speaker or 'phones.

LISTENING TEST RESTRICTED

By the listening test, with present equipment, zero-beat development may be said to be impossible. The amplifiers do not handle the very low frequencies, and besides the acoustical devices do not reproduce them. Both reproducer and 'phones may be said to be dead at 10 cycles, for instance. Hence it is better to use meters.

If the two frequencies are coupled to a single detector, which may be the only detector in a t.r.f. set, or the second detector in a superheterodyne, and if a direct-current meter is placed in series with the plate or anode load of detector, then zero beat may be sensibly determined. When the frequencies are as low as five cycles the meter needle will oscillate at this difference frequency, but when the difference is much more, the needle is too sluggish to follow the pulses. However, zero beat is, relatively, a long way from five cycles, so an oscillator adjustment is made so that the needle moves as little as possible. In practice, due to the difficulty of actually tuning the oscillator to zero beat, where small capacity changes in a circuit, or lack of precise control of the dial mechanism, change one frequency considerably, in terms of resultant difference, two or three cycles may be treated as the minimum attainable.

SERVES A PURPOSE

By the listening test, although zero beat is unattainable, so perhaps 30 or 40 cycles would be the minimum, which is very far from zero. But for generator frequency calibration, or station frequency determination, this is close enough. Response at a frequency sensibly higher than zero, because of acoustical devices' shortcomings and amplifier losses, is valuable since even 50 cycles compared to the radio frequencies used amounts to tiny percentage, indeed the percentage accuracy is something of the order of that required of standard-band broadcasting stations.

It is when the audio differences are to be treated as such that great closeness to zero beat is important, and the actual frequency of the difference becomes vital.

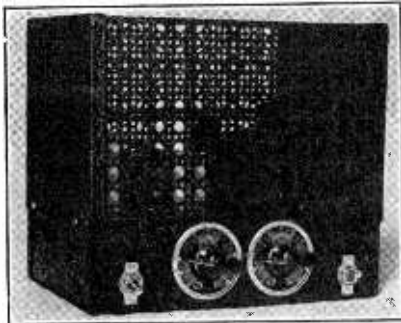

WIDEN FIDELITY RANGE WITH THE DOUGLAS "BABY" VOLUME EXPANDER

Easily attached to Radio or Amplifier. Only Four Connections to make. Outside measurements, width 8" front to back 3½", height 7½". Complete kit of best quality parts mounted on drilled chassis with cover.—Ready to wire.

\$7.95 LESS TUBES

KIT OF 4 SYLVANIA METAL COMPLETE UNIT
OR METAL GLASS TUBES WIRED AND TESTED
\$3.80 **\$2.50 extra**

DOUGLAS RADIO CO.

(TOM AND GEORGE)
PARTS — AMPLIFIERS — TUBES
89 Cortlandt St., N. Y. C.
MAIL ORDERS FILLED 24 HOURS
20% Deposit With Order, Balance C.O.D.

INDUCTANCE BOOK

Free! Every solenoid for every radio-frequency or intermediate frequency may be wound of standard wire on standard form diameters without any computations by using "The Inductance Authority," by Edward M. Shiepe. This \$2 book sent free, postpaid, with supplement, on receipt of \$5 for a 2-year subscription for RADIO WORLD.

RADIO WORLD, 145 W. 45th St., N. Y. C.

So when checking generators or stations, when zero beat is referred to, it is not meant literally, but the suggestion must be read as meaning the closest practical approach to zero beat.

Any generator of intermediate and radio frequencies may be united with another oscillator, generating a low radio frequency range, and of extremely small frequency ratio. If both radio frequencies are calibrated, the resultant audio may be determined by striking the difference. Suppose that the r-f generator produces 110 kc. Suppose the low frequency, small-ratio generator produces 100 to 110 kc. When both are at 110 kc. the resultant beat is zero. When the r-f oscillator of standard range is at 110 kc. and the small-ratio oscillator at 100 kc. the note is 10 kc., or 10,000 cycles.

[Article on audio beats next month]

AN OUTSTANDING ACHIEVEMENT!

RACO AC-4

Communication Receiver
2 1/2-555 Meters

An All-Purpose Receiver That Defies Competition

And when we say communication receiver we MEAN it. The AC-4 is built to the highest amateur specifications for serious communication and long distance reception under all conditions. Isolantite insulated high frequency and band-spread tuning condenser; continuous, all electrical, band-spread; perfect regeneration stability; super-regeneration below 15 meters; and a host of other features. The 20 meter band, for instance, covers 100 degrees on the big 3 1/2" German silver band-spread dial with NO hand capacity effect. You will be amazed at the way the AC-4 separates the crowded foreign stations on the short wave bands.

BUILT-IN A.C. POWER PACK

The AC-4 uses three of the powerful new Sylvania 6J5G tubes as electron coupled detector and two stage audio, plus an 80 rectifier with built-in high voltage supply which is really quiet.

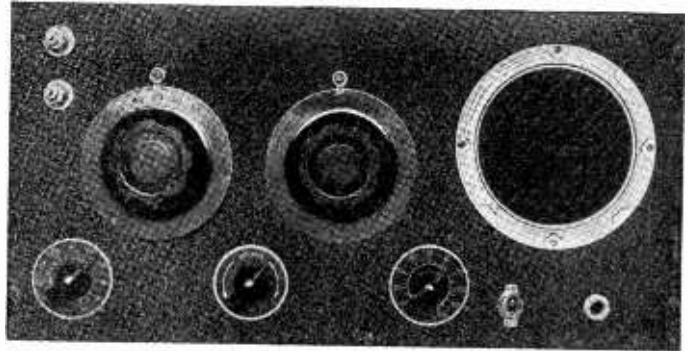

THE MOST REMARKABLE RADIO VALUE WE HAVE EVER OFFERED

Separate panel controls for antenna coupling, audio volume and regeneration. A standby switch is provided and also an earphone jack which cuts out the speaker.

RACO AC-4; Complete Kit of parts, unwired, less \$10-75 only cabinet and tubes.....
Crystalline finished metal cabinet..... 1.25
Kit of four picked Sylvania tubes..... 2.05
Wiring and testing 2.50

SPECIAL PRICE ON COMPLETE RACO AC-4:
wired, tested and ready to operate from any \$15.85
110 volt A.C. line.....

RADIO CONSTRUCTORS LABORATORIES

Dept. RA-3, 136 Liberty St.
New York, N. Y.

Electricity at your finger ends

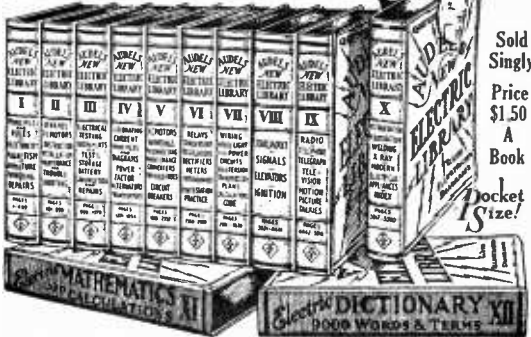

Sold
Singly
Price
\$1.50
A
Book

Pocket
Size!

AUDELS NEW ELECTRIC LIBRARY—A progressive Home Study and Reference Course in applied electricity. Easy to understand. Questions and answers plainly written for a complete working knowledge of modern electrical practice, necessary to every electrician, engineer, mechanic and student.

LEARN THE AUDEL WAY! You ask the question—Audels New Electric Library gives the answer—9500 simplified outlines, graphic illustrations and precise explanations covering Construction, Operation and Machine Maintenance.

BOOK A MONTH PLAN—Order the volume that interests you—today! We will send that volume on 7 days' free trial. If the book helps you, send us \$1.50. If it does not help you, mail book back to us. On receipt of your first payment, we will send your second book. We allow 30 days to pay for this and for each following book until you complete the Series.

If you are not satisfied, you may cancel your subscription at any time.

FREE EXAMINATION COUPON

Theo. Audel & Co., 49 W. 23rd St., New York City
Mail Vol. I, Electric Library on 7 days' free trial. If O. K. I will remit \$1.50, otherwise I will return it. I also request you to mail one book each month on same terms. No obligation unless I am satisfied.

Name
Address
Occupation R. W.

SPECIAL 2-FOR-1 OFFER RADIO WORLD

Radio World is \$2.50 a year (12 issues), 25c. per copy. Canada and foreign, \$3.00 yearly. Offers of Radio World and other worthwhile publications for one full year on each (NET):

- RADIO WORLD and SHORT-WAVE CRAFT, \$3.50.
- RADIO WORLD and POPULAR SCIENCE MONTHLY, \$3.50.
- RADIO WORLD and RADIO-CRAFT (12 issues), \$3.50.
- RADIO WORLD and RADIO INDEX (monthly, 10 issues), stations, programs, etc., \$3.50.
- RADIO WORLD and SERVICE (monthly), \$3.50.
- RADIO WORLD and EVERYDAY SCIENCE AND MECHANICS (monthly), \$3.50.
- RADIO WORLD and BOYS' LIFE (monthly, 12 issues), \$3.50.
- RADIO WORLD and MOTION PICTURE MAGAZINE (monthly), \$3.50.
- RADIO WORLD and TRUE STORY (monthly), \$3.00.
- RADIO WORLD and LIBERTY (weekly), \$3.00. U. S. only.

Select any one of these magazines and get for an entire year by sending in a year's subscription for RADIO WORLD at the regular price, \$2.50, plus a small additional amount, per quotations above. (Add \$1.50 for extra foreign or Canadian postage for both publications.)

Name
Address
City and State.....

CLASSIFIED ADVERTISEMENTS

7 cents a word. \$1.00 minimum.

AMATEUR RADIO, Commercial Radiotelephone and Radio-telegraph licenses, complete training. Resident and correspondence courses. Every graduate a licensed operator. **NEW YORK WIRELESS SCHOOL**, 1123 Broadway, New York.

PRECISION BUILT RADIO and replacement coils. Send for free catalog. **UNITED COIL CO.**, 2334 South Central Park Ave., Chicago, Illinois.

YOUR NAME on 25 paneled cards, 25 cents. 100 and card case \$1.00. Postpaid. Simpson Printing Company, Winston-Salem, North Carolina.

40 ACRES—near White River, unimproved, poultry land, \$100; \$5 down. \$5 monthly. Free list and literature. Hubbard, 274 Grossman Bldg., Kansas City, Kansas.

\$50. A WEEK WITH A KODAK: Booklet describing 100 Magazine Markets, 25 cents, postpaid. Hammons, Box 265, Corbin, Kentucky.

RADIO WORLD and **POPULAR MECHANICS MAGAZINE**—Radio World is \$2.50 a year, and Popular Mechanics Magazine is \$2.50 a year. Popular Mechanics Magazine does not cut rates, but Radio World will send both publications to you for one year for \$3.75. **RADIO WORLD**, 145 West 45th Street, New York City.

TRAINED RADIO SINGER AVAILABLE: Ballads and descriptive numbers. Folk songs. Baritone with appealing quality of tone. Offers numbers rendered by Frank Munn, Richard Crooks, John Charles Thomas. Some of John McCormack's and a few old Chauncey Olcott hits. Address principal: Peter A. Rogers, 1619 Third Ave., Watervliet, N. Y.

HAVE YOU BACK NUMBERS of Radio World, August, 1935, or June, 1936, issues? If so, please communicate with Radio World, 145 West 45th Street, New York, N. Y.

Now—a high-powered



Radio Engineering Library

- especially selected by radio specialists of McGraw-Hill publications.
- to give most complete, dependable coverage of facts needed by all whose fields are grounded on radio fundamentals.
- available at a special price and terms.

THESE books cover circuit phenomena, tube theory, networks, measurements, and other subjects—give specialized treatment of all fields of practical design and application. They are books of recognized position in the literature—books you will refer to and be referred to often, if you are a practical designer, researcher or engineer in any field based on radio, you want these books for the help they give in hundreds of problems throughout the whole field of radio engineering.

NEW!

The Library now comprises a revised selection of books culled from latest McGraw-Hill publications in the radio field.

- 5 volumes, 3064 pages, 2000 illustrations
1. Glasgow's **PRINCIPLES OF RADIO ENGINEERING**
 2. Hund's **PHENOMENA in HIGH FREQUENCY SYSTEMS**
 3. Chaffee's **THEORY OF THERMIONIC VACUUM TUBES**
 4. Terman's **MEASUREMENTS IN RADIO ENGINEERING**
 5. Henny's **RADIO ENGINEERING HAND-BOOK**

10 days' examination. Special price. Monthly payments. \$25.00 worth of books cost you only \$23.50 under this offer. Add these standard works to your library now; pay small monthly installments, while you use the books.

SEND THIS ON-APPROVAL COUPON

McGraw-Hill Book Co., Inc., 330 W. 42nd St., N. Y. C.

Send me Radio Engineering Library, 5 vols., for 10 days' examination on approval. In 10 days I will send \$2.50, plus few cents postage, and \$3.00 monthly till \$28.50 is paid, or return books postpaid. (We pay postage on orders accompanied by remittance of first installment.)

Name

Address

City and State

Position

Company

R. W. 3-37

"I know I can depend on **ALLIED** for real ham equipment, crack service and lowest prices!"—
the word goes from ham to ham

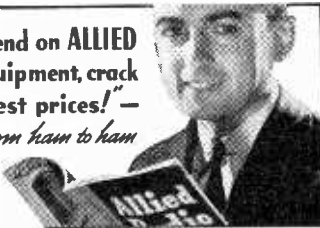

At every Hamfest—wherever Amateurs get together to "chew the fat" and compare notes and ideas, the conversation always turns to "What's **ALLIED** doing now?" Hams everywhere know that **ALLIED** leads in presenting the newest worthwhile developments in Radio, that the **ALLIED** Catalog is the index to the finest short wave gear that money can buy. Further, our Technical Staff, composed of Engineers and Licensed Amateurs, is always at your service, to aid you in selecting the equipment you need—personally, accurately and economically. That's why **ALLIED** is known everywhere as "The Tops in Amateur Radio."

Everything in Radio at Lowest Prices

Send for the big 1937 **ALLIED** Radio Catalog. It includes more than 10,000 exact duplicate and replacement parts; complete lines of Amateur transmitters, receivers, and transceivers, in both factory-built and kit form; test instruments; Build-Your-Own kits; Public Address equipment; 38 new Knight Radios; Ruripower generators and Windchargers; books, tools, etc. Write for your **FREE** copy today!

ALLIED RADIO

833 W. Jackson Blvd., Dept. 16-C
Chicago, Ill.

Send me your 1937 **ALLIED** Catalog.

Name

Address

City..... State.....





CONDENSER ANALYZER

- OPERATES FROM 110V A.C.
- SHOWS CONDENSER LEAKAGE.
- SHOWS OPEN'S AND SHORT'S.
- CAPACITY DIRECT READING SCALE .001 TO 20 MFD.
- USED AS AN OUTPUT INDICATOR.
- A 4 PURPOSE INSTRUMENT PUT UP IN AN ATTRACTIVE CARRYING CASE WITH A NATURAL WOOD FINISH.

NEW

MODEL 401 CONDENSER ANALYZER

Condenser capacities are read on a direct reading scale. The circuit is of the "Bridge" type, using fixed condensers as standards.

A neon leakage tester that tells when a condenser is shorted, open or whether it leaks and how badly.

An output indicator with an adjustable shunt voltage control which permits the indicator to be adjusted to its most sensitive indicating point. A valuable and necessary instrument for lining up superhet's, adjusting trimming and padding condensers and I.F. amplifiers.

This 4 in 1 instrument was designed with the practical needs of the serviceman and experimenter in mind. They will find it rugged, absolutely fool-proof and dependable for fast, accurate service work.

It is entirely portable with two tubes (Indicator and Rectifier), ready to operate.

MODEL 401 Condenser Analyzer Absolutely Complete with 2 Tubes and Test Prods, Cased in a Portable Natural Wood Finished Case with a Leather Handle **\$9.10**

NATIONAL RADIO LABS.

32 Neptune Avenue

DEPT. R-101

Jersey City, N. J.

Don't Let the Price Worry You!

WORRY about price is universal. If not based on the price being beyond one's easy ability to pay, the worry is based on whether the price one can pay will purchase a product of the quality one requires. That is, the price seems either too high or not high enough.

Certainly the price of our Model T-37 Signal Generator is not too high—\$12.40, wired, complete with three tubes. In fact, it is the lowest price of any all-wave universal Signal Generator. The question then arises, Is this Signal Generator good enough for your exacting purposes?

We know that it is, but we ask you to follow closely our sincere exposition of the reasons.

WE make only a single model Signal Generator, the T-37, and therefore can concentrate our efforts on producing a perfected instrument.

The accuracy of this Signal Generator is one half of one per cent. on the two i.f. bands and one per cent. on the broadcast band. The percentage accuracy is always a good test of the skill with which a Signal Generator is made. Our accuracy is far greater than price would suggest.

Recently the accuracy was improved to the percentages just given, and a new precision indicating system had to be introduced into the T-37 to capitalize the scale accuracy.

I. F., R. F.
A. F.
Leakage
Continuity
•
Four
Services



And
the
Price
Complete
\$12.40

Demand the Accuracy You Require

Instead of encouraging you to accept low accuracy for the sake of low price, we ask you to demand extremely high accuracy despite low price. We recently spent a hundred hours calibrating our new direct-frequency reading scale, we check the tuning condenser for capacity settings, we check frequency at 10 or more points on each band, we check attenuation and we check the tubes, besides checking the audio, the leakage and the continuity services.

All Waves, Attenuation, Optional Modulation

By taking most extreme care at every step, by making purchases in large quantities, and by long training of our engineering and factory personnel, we have been able to attain the end that has baffled all others—the manufacture of a Signal Generator priced as the worst and performing as the best!

We do not speed up our production or permit anything save precision manufacture, therefore best engineering and labor are assured. Our workmen perform their unhurried tasks amid finest factory conditions, with crystal oscillator precision as their watchword—all to your lasting benefit.

Competing manufacturers have sent for our

T-37 to try to find out "how we do it." One even wrote us he didn't see how we could sell the Signal Generator at \$12.40 without suffering a loss. Well, we're not so sure about that ourselves, but we are sure of this: the T-37, now in its second year, is nearly "tops" for accuracy, and positively "tops" for value.

Frequencies are direct-reading in five bands, covering 100 kc to 22 mc, by band-switching. Frequencies of each band also imprinted at the switch stop. An attenuator (volume control) is included. Modulation is present or absent, by separate switching. Separate audio output, condenser leakage tests and continuity probing are provided for. Order a T-37 (shipping weight 7 lbs.).

SUPERIOR INSTRUMENTS CO. 139 Cedar Street, New York, N. Y.
Dept. 103

You need these books!



417 THINGS EVERY RADIO SERVICE MAN MUST KNOW

Ghirardi gives you EVERYTHING you need to know about modern radio servicing in these two indispensable, up-to-date reference books, gives you complete information on all the 417 essentials of radio servicing today (1700 pages full). Both big books are copiously illustrated. You NEED them both—one to explain clearly the most successful modern repair and test methods—the other to give you invaluable quick-use Job data for work in line with SUPPLEMENTS twice a year. Everyone uses the field or in the shop!—it's kept up-to-date Permanent-Ghirardi today. Get your copies NOW. Mail the coupon today!

Just a sample of what you'll get—

- ★ HOW to use all kinds of test instruments. How they work. Complete construction models.
- ★ HOW to use the most successful modern methods in repairing receivers. "Case Histories" of over 1,500 receivers and time-saving, money-making shortcuts in service work.
- ★ HOW to align any make of superhet. and—
- ★ HOW to use the Cathode-Ray Oscillator method in alignment work.
- ★ HOW to track down and eliminate every type of noise and interference.
- ★ HOW to save time on all difficult trouble-shooting and repair jobs. New dope on tests and remedies for hum, intermittent reception, distortion, etc.
- ★ HOW to install and service all makes of auto-radio receivers in all makes of cars and eliminate ignition interference.
- ★ HOW to master all the complexities of AVC and QAVC circuits and troubleshoot them.

MODERN RADIO
1300 pp. *Servicing* 706 Ill. \$4.
RADIO FIELD SERVICE DATA
436 pp. 107 Ill. \$2.50

GET BOTH BIG BOOKS on our Special Combination Offer INCLUDING JAN. and JUNE 1937 SUPPLEMENTS to DATA BOOK

\$6

CLIP and MAIL TODAY

RADIO & TECHNICAL PUBL. CO., Dept. RW-37
45 Astor Place, New York

- Enclosed find \$6, for BOTH BOOKS, including Jan. and June '37 Supplements.
- Send FREE circulars on these books.
- Data on your other radio issues.

Name

Address

MONEY BACK GUARANTEE!

METAL CHASSIS

We can supply chassis for any make receiver, experimental or otherwise.

Inquiries should be accompanied with sketch and complete details enabling us to give quick service as to prices and delivery.

KORROL MFG. CO., Inc.

232 Greenwich St. Dept. RW-337 N. Y. City

The EXPERIMENTERS TREASURE HOUSE

Since 1923, we have been catering to the needs of Radio and Electrical Experimenters. From cat-whisker to television tubes, miniature motors, relays from 29c to \$6.50—photoelectric cells, neon lamps from 15c to \$1.50, in fact anything and everything you may need, in stock or know where to obtain for you. We have been shopping agents for well-known schools and institutions for many years, why not for you?

Headquarters for Parts—Since 1923

BLAN

THE RADIO MAN, INC.

W-177 Greenwich St., New York, N. Y.

NO CATALOGUE—BUT LOWEST PRICES

"I Don't Worry"

About Radio Supply Troubles



Neither Does Our Radio Man . . .

HE BUYS AT RADOLEK!

He saves time! He saves money! He doesn't have to "split" his orders. He's happy and making money . . . because he uses Radolek's Radio Supply Service . . . the finest, fastest, most complete source of radio parts in the world. Radolek SPECIALIZES in giving the radio-man what he wants, when he wants it, and at the right prices. This new 1937 Radolek Radio Profit Guide is just off the press. . . . Over 12,000 values. . . . Hundreds of new items.



Merchandise you've never seen before. Repair Parts, Radio Sets, Amplifiers, Test Instruments, Tubes, Tools, Books, "everything in Radio and Public Address." You need this complete "guide" to greater profits. Send for yours today. FREE!

RADOLEK

601 W. RANDOLPH, CHICAGO, DEPT. G4

Send me the Radolek Radio Profit Guide FREE.

Name

Address

Servicemen? Dealer? Experimenter?

NC-100 RECEIVER



1. PERMITS COMPACT WIRING

Unlike a coil switch, there are no long leads in the NC-100 Receiver. Each coil range in turn is brought into position directly below the tuning condenser, and close to the tube. This compactness results in a minimum of stray capacitance and stray inductance, resulting in high gain without instability. It permits a smaller tuning condenser capacity, with improved performance at high frequencies.

2. ISOLATES IDLE COILS

Each of the fifteen H/F coils is in its own individual shield, and idle coils are always out of the way. There are no dead spots and absorption losses in the NC-100 Receiver. The heavy cast aluminum shield is located at the bottom of the receiver where it is protected from the heat of the tubes and power supply. Its generous proportions retard temperature changes.

3. ASSURES PRECISE TUNING

The shifting mechanism brings each set of coils into positive, exact position. Unlike many coil switches, turning the range changing knob does not tune the receiver. The Micrometer Dial contributes a smoothness that makes tuning easy, and an accuracy that makes logging precise. The effective scale length is twelve feet, and readings are direct to one part in five hundred.



NATIONAL COMPANY, INC., MALDEN, MASS.

Handy... and for 1000 Uses



SIZE
3 1/16" x 5 5/8" x 2 1/2"

Pocket Volt-Ohm- Milliammeter

● For laboratory, shop or field use. Handy Pocket size yet sturdy and precision built.

Model 666

Dealer Price **\$15.00**

A complete instrument for all servicing needs. Can be used for all A.C.-D.C. voltage, current and resistance analyses.

Leather Carrying Case, Model 669, supplied extra. Dealer Price ... \$3.00.

Very attractive. Of black, heavy leather with finished edges and strap.

Model 666

- Uses Large 3" Sq. Triplet Instrument.
- A.C.-D.C. Voltage Scales Read: 10-50-250-500-1000 at 1000 ohms per volt.
- D.C. Milliampere Scale Reads: 1-10-50-250.
- Ohms Scales Read: Low 1/2-300; High 250,000.
- Black Molded Case and Panel.
- Low Loss Selector Switch.
- Complete with Alligator Clips, Battery and Test Leads.

DEALER PRICE **\$15.00**

SEE YOUR JOBBER - WRITE FOR CATALOG



ELECTRICAL INSTRUMENTS

The Triplet Electrical Instrument Co.
273 Harmon Avenue, Bluffton, Ohio.

—Without obligation please send me more information on Model 666.

—I am also interested in.....

Name

Address

City State